

ENGLISH

Canon

PowerShot A580

Camera User Guide



Getting Started

p. 9

Ensure that you read the Safety Precautions (pp. 158 – 165).

DiG!C III

PictBridge

DIRECT
PRINT

BUBBLE JET
DIRECT

Exif Print

DPOF

HI-SPEED
CERTIFIED
USB

Confirming the Package Contents

The following items are included in the package. If something is missing please contact the retail outlet at which you purchased the product.

1 Camera



2 AA-size Alkaline Batteries (x2)



3 Memory Card (32 MB)



4 Interface Cable IFC-400PCU

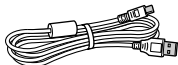

5 AV Cable AVC-DC300



6 Wrist Strap WS-800

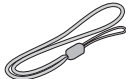

7 Canon Digital Camera Solution Disk



8 European Warranty System (EWS) Booklet



9 User Guides



Getting Started Guide



Canon Digital Camera Manuals Disk

You may not be able to achieve the full performance of this camera with the included memory card.

Let's Get Started!

This guide is divided into the following two sections.

First...

Getting Started

p. 9

This section explains how to prepare the camera for use and the basics of shooting, viewing and printing images. Start out by familiarizing yourself with the camera and mastering the basics.

Next...

Learning More

p. 39

Once you have mastered the basics, use the camera's many features to shoot more challenging photos. Details on using each function are described in this section, including how to connect the camera to a television to view images.



The PDF Manuals are included in the supplied CD-ROM.

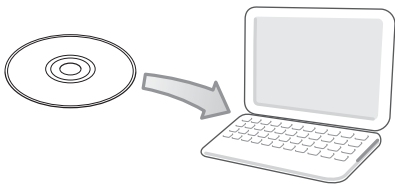

Adobe Reader is required to view the PDF Manuals.
<http://www.adobe.com>

Table of Contents

Items marked with a ☆ are lists or charts that summarize camera functions or procedures.

Please Read	6
-------------------	---

Getting Started 9

Preparations	10
Shooting Still Images ( Mode)	15
Viewing Still Images	18
Erasing	19
Printing	20
Embedding the Date in the Image Data	22
Shooting Movies ( Standard Mode)	24
Viewing Movies	26
Downloading Images to a Computer	27
System Map	34

Learning More 39

Components Guide 40







Indicators	43
------------------	----

Basic Operations 44

☆ Menus and Settings	44
☆ Information Displayed on the LCD Monitor and Menus ...	46
Using the LCD Monitor	53

Commonly Used Shooting Functions 55

  Using the Optical Zoom	55
Using the Digital Zoom/ Digital Tele-Converter	55
 Using the Flash	59
 Shooting Close-ups (Macro)	60
 Using the Self-Timer	61
Changing the Recording Pixels (Still Images)	63

Changing the Compression (Still Images)	64
 Adjusting the ISO Speed	65
Shooting Using the Mode Dial	66
<hr/>	
Mode Dial	66
Shooting Modes for Specific Scenes	67
Shooting in the Manual Mode	70
 Movie Shooting	71
Advanced Shooting Functions	75
<hr/>	
 Continuous Shooting	75
Setting the Flash	76
Checking the Focus and Peoples' Expressions	78
Selecting an AF Frame Mode	82
Selecting a Subject to Focus On (Face Select and Track)	84
Shooting Hard-to-Focus Subjects (Focus Lock, AF Lock)	86
Locking the Exposure Setting (AE Lock)	88
Shooting with FE Lock	89
Adjusting the Exposure Compensation (Still Images)	90
Switching between Metering Modes	91
Setting a Slow Shutter Speed (Long Shutter Mode)	92
Adjusting the Tone (White Balance)	94
Shooting in a My Colors Mode	97
Setting the Display Overlays	99
Categorizing Images Automatically (Auto Category)	100
Registering Settings to the  Button	101
Playback/Erasing	103
<hr/>	
 Viewing Magnified Images	103
 Viewing Images in Sets of Nine (Index Playback)	104
Check the Focus and Facial Expressions of Subjects (Focus Check Display)	105
 Jumping to Images	107
Organizing Images by Category (My Category)	109
Viewing Movies	110
Rotating Images in the Display	112
Playback with Transition Effects	113

Automated Playback (Slide Shows)	114
Red-Eye Correction Function	115
Resizing Images	120
Attaching Sound Memos to Images	122
Protecting Images	124
Erasing All Images	125
Print Settings/Transfer Settings	126
Setting the DPOF Print Settings	126
Setting the DPOF Transfer Settings	130
Configuring the Camera	132
Power Saving Function	132
Formatting Memory Cards	134
Resetting the File Number	135
Creating an Image Destination (Folder)	137
Setting the Auto Rotate Function	139
Resetting Settings to Their Default Values	140
Connecting to a TV	141
Shooting/Playback Using a TV	141
Troubleshooting	143
List of Messages	154
Appendix	158
Safety Precautions	158
Preventing Malfunctions	164
Using the Power Kits (Sold Separately)	167
Using an Externally Mounted Flash (Sold Separately)	171
Replacing the Date Battery	173
Camera Care and Maintenance	175
Specifications	176
Index	185
★ Functions Available in Each Shooting Mode	189

About this Guide

Symbol Conventions in this Guide

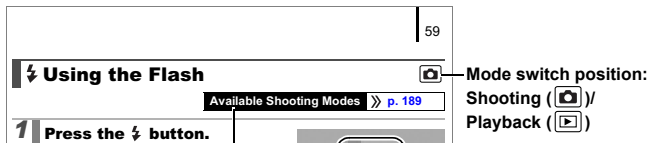

Some functions may not be available in certain shooting modes.
If there is no notation to that effect, the function may be used in all modes.



: This mark denotes issues that may affect the camera's operation.



: This mark denotes additional topics that complement the basic operating procedures.

Explanations in this guide are based on the camera's default settings at time of purchase.

Specifications are subject to change without prior notice. As a result, the illustrations and screenshots used in this guide may differ from the actual camera.



You can use SD memory cards, SDHC (SD High Capacity) memory cards, MultiMediaCards, MMCplus cards and HC MMCplus cards in this camera. These memory cards are collectively referred to as memory cards in this guide.

Please Read

Test Shots

Before you try to photograph important subjects, we highly recommend that you shoot several trial images to confirm that the camera is operating and being operated correctly.

Please note that Canon Inc., its subsidiaries and affiliates, and its distributors are not liable for any consequential damages arising from any malfunction of a camera or accessory, including memory cards, that results in the failure of an image to be recorded or to be recorded in a way that is machine readable.

Warning Against Copyright Infringement

Please note that Canon digital cameras are intended for personal use and should never be used in a manner that infringes upon or contravenes international or domestic copyright laws and regulations. Please be advised that in certain cases the copying of images from performances, exhibitions, or commercial properties by means of a camera or other device may contravene copyright or other legal rights even if the image was shot for personal use.

Warranty Limitations

For information on your camera's warranty, please refer to the Canon European Warranty System (EWS) Booklet supplied with your camera. **For Canon Customer Support contacts, please see the European Warranty System (EWS) Booklet.**

Camera Body Temperature

If your camera is used for prolonged periods, the camera body may become warm. Please be aware of this and take care when operating the camera for an extended period.

About the LCD Monitor

The LCD monitor is produced with extremely high-precision manufacturing techniques. More than 99.99% of the pixels operate to specification. Less than 0.01% of the pixels may occasionally misfire or appear as red or black dots. This has no effect on the recorded image and does not constitute a malfunction.

Video Format

Please set the camera's video signal format to the one used in your region before using it with a TV monitor ([p. 141](#)).

Language Setting

Please see *Setting the Display Language* ([p. 14](#)) to change the language setting.

Getting Started

- **Preparations**
- **Shooting Still Images**
- **Viewing Still Images**
- **Erasing**
- **Printing**
- **Embedding the Date in the Image Data**
- **Shooting Movies**
- **Viewing Movies**
- **Downloading Images to a Computer**
- **System Map**

Preparations

Installing the Batteries and Memory Card

1. Slide and hold the battery cover lock (①), then slide (②) and open (③) the cover.

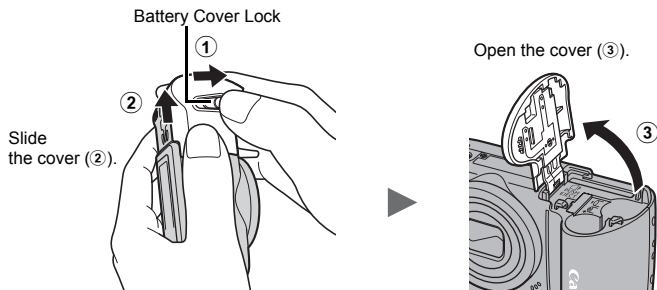

2. Install two batteries.

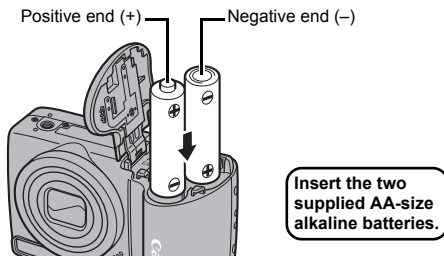

3. Insert the memory card until it clicks into place.

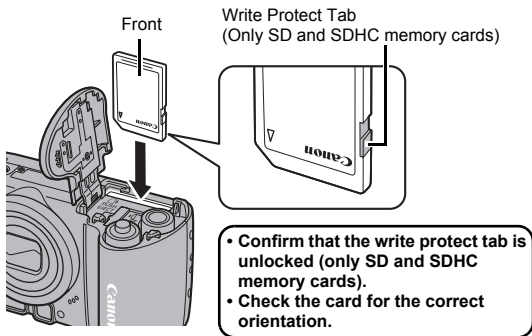

4. Close the cover (④), and press downward as you slide it until it clicks into place (⑤).

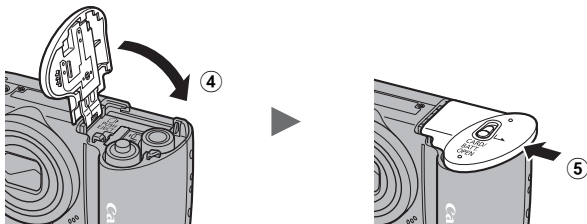

Ensure that the memory card is correctly oriented before inserting it in the camera. Inserting it backward may cause the camera to fail to recognize the memory card or to malfunction.

To Remove the Batteries

Open the cover and remove the batteries.

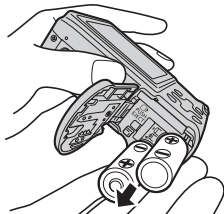

Take care that you do not drop the batteries.

To Remove the Memory Card

Use a finger to push the memory card in until you hear a click, then release it.

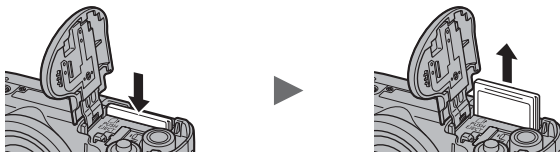

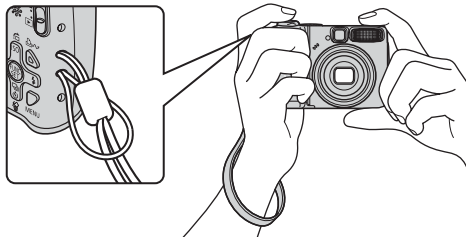

Use the wrist strap to avoid dropping the camera during use.

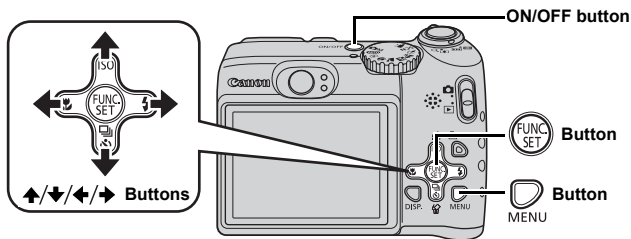

Setting the Date and Time

The Date/Time settings menu will appear the first time the power is turned on.





1. Press the ON/OFF button.
2. Select the month, day, year and time, and the display order.
 1. Use the ← or → button to select an option.
 2. Use the ↑ or ↓ button to set the value.
3. Press the  button.



To Change a Previously Set Date/Time

Use the following procedures to display the Date/Time settings window, and then perform Steps 2 and 3 above.

1. Press the  button.
2. Use the ← or → button to select the  (Set up) menu.
3. Use the ↑ or ↓ button to select [Date/Time].
4. Press the  button.

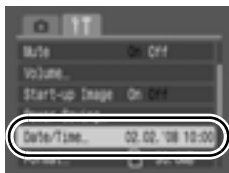









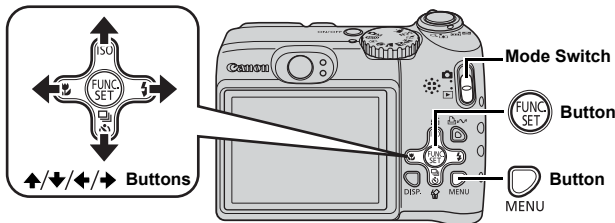

The date/time setting screen will appear when the capacity of the lithium date/time battery is depleted (p. 173).

Setting the Display Language

You can change the language displayed in the LCD monitor menus and messages.



1. Set the mode switch to  (playback).
2. Hold down the  button and press the  button.
3. Use the , ,  or  button to select a language.
4. Press the  button.

Shooting Still Images (AUTO Mode)

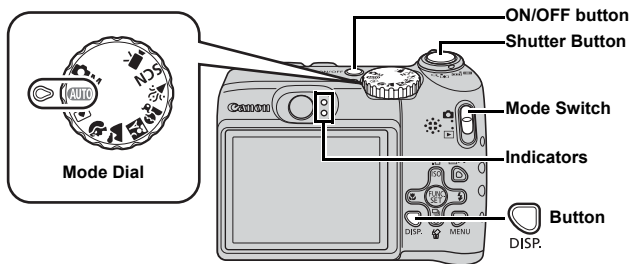

1. Press the ON/OFF button.

- The start-up sound will play and the start-up image will display in the LCD monitor.
- Pressing the ON/OFF button again turns the power off.

2. Select a shooting mode.

1. Set the mode switch to  (shooting).
2. Set the mode dial to **AUTO**.



3. Aim the camera at the subject.

Avoiding Camera Shake

Keep your arms tight against your body while holding the camera firmly by the sides. Using a tripod is also effective.



4. Press the shutter button lightly (halfway) to focus.

- When the camera focuses, it beeps twice and the indicator lights.

5. Press the shutter button fully (all the way) to shoot.

- The shutter sound will play once and the image will record.
- Recorded images are displayed on the LCD monitor for approximately 2 seconds immediately after shooting (Rec. Review). You can shoot by pressing the shutter button even when an image is being displayed.
- If you hold the shutter button down after a shot, the image will continue to display.
- The indicator will blink green and the file will record to the memory card.

To Shoot Images in Focus

The camera automatically sets the focus when you press the shutter button halfway*.

* The shutter button has a two-stage action. Pressing it down to the first stage is referred to as "pressing halfway".

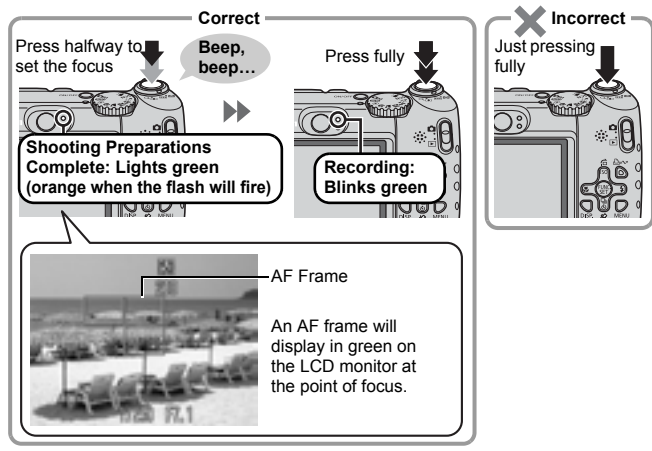

Mute Setting

When you hold down the **DISP.** button while turning on the camera, the mute setting will be set to [On]. You can change the setting in [Mute] in the Set up menu (p. 51).

Shooting in Easy Mode

This camera features a shooting mode, Easy mode, that automatically selects all camera settings except the flash. This mode is ideal for first time camera users, or users who do not make many settings. You can select whether or not to use the flash with the  button, allowing you to take images even where flash photography is prohibited.

1. Set the mode dial to  (Easy mode).



2. Aim the camera at the subject.
3. Press the shutter button halfway to focus.
4. Press the shutter button fully to shoot.



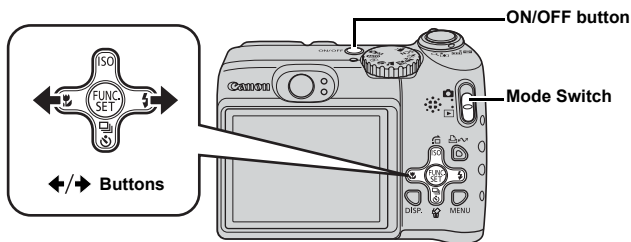

No settings, other than flash settings, can be made in Easy mode. Even if you press the **MENU** or **FUNC./SET** button, no menu will display.

Viewing Still Images



1. Press the ON/OFF button.
2. Set the mode switch to  (playback).
3. Use the  or  button to display the image you wish to view.





- Use the  button to move to the previous image and the  button to move to the next image.
- The images advance more quickly if you keep the button pressed, but they will appear coarse.

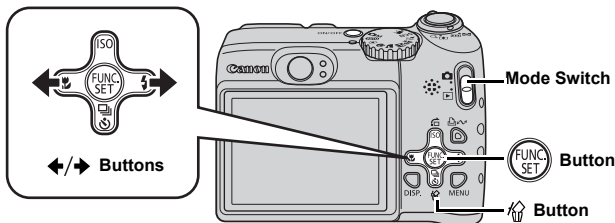

- Setting [Resume] to either [Last seen]* or [Last shot] in the  menu allows you to specify the image to display in playback mode. (* Default setting)
- If you select [Last seen], the last image viewed will display (Resume Playback).
- The following actions will display the most recent image regardless of the [Resume] settings.
Shooting an image, changing the memory card, or editing an image on the memory card using a computer.

Erasing



1. Set the mode switch to  (playback).
2. Use the  or  button to select an image to erase and press the  button.
3. Confirm that [Erase] is selected and press the  button.
To exit instead of erasing, select [Cancel].



Please note that erased images cannot be recovered. Exercise adequate caution before erasing an image.

Printing

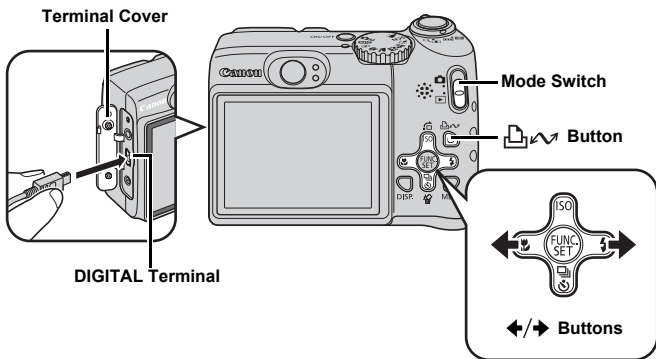

1. Connect the camera to a direct print compatible printer.

- Open the terminal cover and plug the interface cable in all the way.
- See the printer's user guide for connection instructions.
- Since this camera uses a standard protocol (PictBridge), you can use it with other PictBridge-compliant printers in addition to Canon-brand printers.

For details, see the *Direct Print User Guide*.

2. Turn on the printer.

3. Set the mode switch to (playback) and press the ON/OFF button.

- The  button will light blue.

4. Use the or button to select an image to print and press the button.

- The  button will blink blue and printing will start.





Printing from a Print List



You can add images directly to a print list by merely pressing the  button immediately after shooting or playing back an image. You can then print the images from the print list easily, when connecting the camera to a printer.

Add to the Print List

1. Press the  button (still images only).

2. Add to the print list.

1. Use the  or  button to select the number of print copies.
2. Use the  or  button to select [Add].
3. Press the  button.

- To remove an image from the print list, press the  button again, use the  or  button to select [Remove] and press the **FUNC./SET** button.







Printing Images in a Print List

This explanation is based on the use of a Canon SELPHY ES series or SELPHY CP series printer.

1. Connect the camera to the printer.

2. Print the image.

1. Use the  or  button to select [Print now].
- You can use the  or  button to confirm the images added to the print list.

2. Press the  button.

- Printing will start.
- If printing is halted and resumed, printing will start from the next image in the queue.

Number of copies to print



Embedding the Date in the Image Data

This section explains how to embed date information on images as they are recorded (Date Stamp).

- The date stamp cannot be deleted from the image data once it has been embedded. Ensure that the camera's date/time is set correctly beforehand (p. 13).
- The image size is fixed to the 2M (1600 × 1200) setting and the compression to Fine (appropriate for printing L-size or postcard-size prints.)

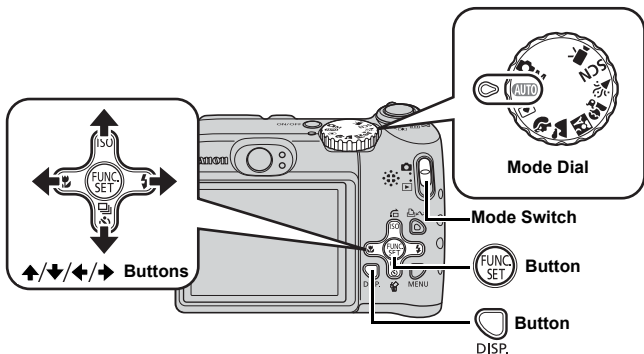

1. Press the ON/OFF button.











2. Select a shooting mode.

1. Set the mode switch to  (shooting).

2. Set the mode dial to **AUTO**.

- You can also make this setting in other shooting modes (except Easy and movie modes).

3. Select (Date Stamp).

1. Press the  button.
2. Use the  or  button to select .
3. Use the  or  button to select .
 - The area that will not print displays in gray.
 - Press the  button to switch to [Date & Time] with the  or  button.







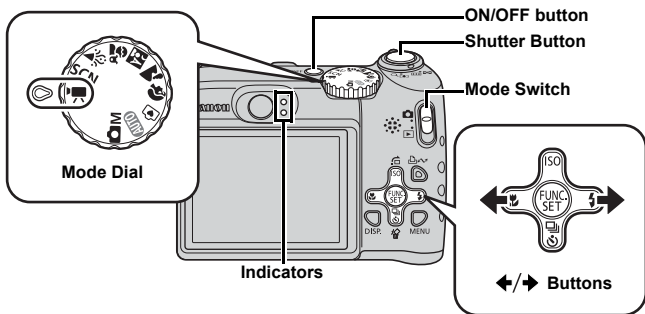

You can use the following methods to imprint the date on images lacking imprinted date stamps.

- Set with the camera's Digital Print Order Format (DPOF) function. Set [Date] option to [On] in [Print Settings] in the  (Print) menu.
- Connect the camera to a printer and imprint the date. See the *Direct Print User Guide*.
- Insert a memory card into the printer and imprint the date. See your printer user guide.
- Use the supplied software. See the *Software Starter Guide*.

Shooting Movies (Standard Mode)



1. Press the ON/OFF button.
2. Select a shooting mode.
 1. Set the mode switch to  (shooting).
 2. Set the mode dial to  (Movie).
 3. Press the  button.
 4. Use the  or  button to select  (Standard).
 5. Press the  button.



3. Aim the camera at the subject.



- Do not touch the microphone while recording.
- Do not press any buttons other than the shutter button. The sound that buttons make will be recorded in the movie.



4. Press the shutter button halfway to focus.

- When the camera focuses, it beeps twice and the indicator lights green.
- The exposure, focus and white balance are automatically set.



5. Press the shutter button fully to shoot.

- Recording starts.
- During the recording, the elapsed recording time and [●Rec.] will display in the LCD monitor.

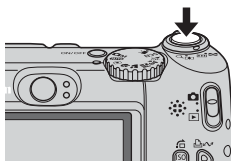

Elapsed Time



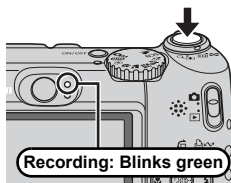

6. Press the shutter button fully again to stop recording.

- The indicator will blink green and the data will be recorded onto the memory card.
- Recording will stop automatically when the maximum recording time elapses, or the built-in memory or memory card become full.

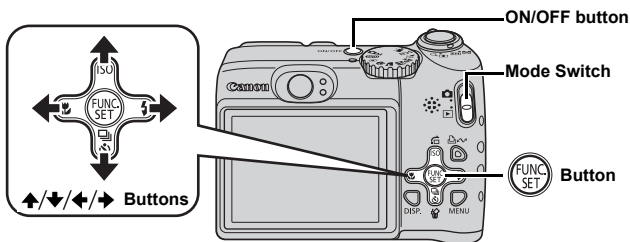



Viewing Movies



1. Press the ON/OFF button.
2. Set the mode switch to  (playback).
3. Use the  or  button to display a movie and press the  button.
 - Images with a  icon are movies.



4. Use the  or  button to select  (Play) and press the  button.

- The movie will start playing.
- If you press the **FUNC./SET** button during playback, you can pause and restart the movie.
- You can adjust the playback volume with the  or  button.



Downloading Images to a Computer

We recommend to use the supplied software.

Items to Prepare

- Camera and computer
- Canon Digital Camera Solution Disk supplied with the camera
- Interface cable supplied with the camera

System Requirements

Please install the software on a computer meeting the following minimum requirements.

■ Windows

OS	Windows Vista Windows XP Service Pack 2 Windows 2000 Service Pack 4
Computer Model	The above OS should be pre-installed on computers with built-in USB ports.
CPU	Windows Vista : Pentium 1.3 GHz or higher Windows XP / Windows 2000 : Pentium 500 MHz or higher
RAM	Windows Vista : 512 MB or more Windows XP / Windows 2000 : 256 MB or more
Interface	USB
Free Hard Disk Space	<ul style="list-style-type: none"> • Canon Utilities - ZoomBrowser EX : 200 MB or more - PhotoStitch : 40 MB or more • Canon Camera TWAIN Driver : 25 MB or more
Display	1,024 × 768 pixels/High Color (16 bit) or better

■ Macintosh

OS	Mac OS X (v10.3 – v10.4)
Computer Model	The above OS should be pre-installed on computers with built-in USB ports.
CPU	PowerPC G3/G4/G5 or Intel Processor
RAM	RAM 256 MB or more
Interface	USB
Free Hard Disk Space	<ul style="list-style-type: none"> • Canon Utilities - ImageBrowser : 300 MB or more - PhotoStitch : 50 MB or more
Display	1,024 × 768 pixels/ 32,000 Colors or better

Preparing to Download Images

With Windows 2000, ensure that you install the software first before connecting the camera to the computer.

1. Installing the software.

■ Windows

1. Place the Canon Digital Camera Solution Disk in the computer's CD-ROM drive.
2. Click [Easy Installation].
Follow the onscreen messages to proceed with the installation.

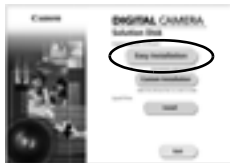

3. Click [Restart] or [Finish] once the installation is complete.

When the installation is finished, [Restart] or [Finish] will display. Click the button that appears.



4. Remove the CD-ROM from the drive when your normal desktop screen appears.

■ Macintosh

Double-click the  icon in the CD-ROM window. When the installer panel appears, click [Install]. Follow the onscreen instructions to proceed.



2. Connecting the camera to a computer.

1. Connect the supplied interface cable to the computer's USB port and to the camera's DIGITAL terminal.

Open the camera's terminal cover and insert the interface cable all the way into the connector.

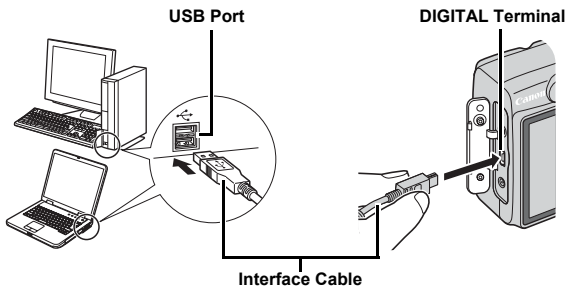

3. Preparing to download images to the computer.

1. Set the mode switch to  (playback) to turn the camera on.

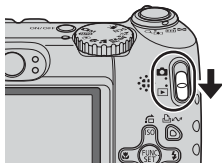

If the Digital Signature Not Found window appears, click [Yes]. The USB driver will automatically finish installing onto the computer when you attach the camera and open a connection.

4. Open the CameraWindow.

■ Windows

Select [Canon CameraWindow] and click [OK].



If the window above does not appear, click the [Start] menu and select [All Programs] or [Programs], followed by [Canon Utilities], [CameraWindow], [CameraWindow] and [CameraWindow].

CameraWindow appears.



■ Macintosh

The CameraWindow will appear when you establish a connection between the camera and computer. If it fails to appear, click the [CameraWindow] icon on the Dock (the bar which appears at the bottom of the desktop).

Preparations for downloading images are now finished. Please proceed to the *Downloading Images Using the Camera* section (p. 31) (except Windows 2000).



- Refer to the *Software Starter Guide* for details on downloading images using the computer.
- With Windows 2000, you can download images using the computer.

Downloading Images Using the Camera (Direct Transfer)

Use this method to download images using camera operations (except Windows 2000).

Install the software before downloading images via the direct transfer method for the first time (p. 28).

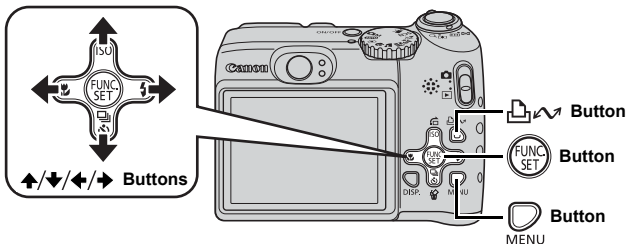

1. Confirm that the Direct Transfer menu is displayed on the camera's LCD monitor.

- The  button will light blue.
- Press the **MENU** button if the Direct Transfer menu fails to appear.

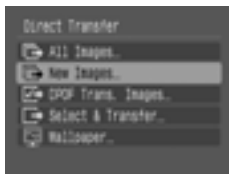





Direct Transfer Menu

2. Press the button.

- Images not previously downloaded will download to the computer.

You can also use the following options in the Direct Transfer menu to set the method for downloading images.

	All Images	Transfers and saves all images to the computer.
	New Images	Transfers and saves to the computer only the images that have not been previously transferred.
	DPOF Trans. Images	Transfers and saves to the computer only the images with DPOF Transfer Order settings.
	Select & Transfer	Transfers and saves single images to the computer as you view and select them.
	Wallpaper	Transfers and saves single images to the computer as you view and select them. The transferred images display as the background on the computer desktop.





All Images/New Images/DPOF Trans. Images

1. Use the **↑** or **↓** button to select , , or  and press the  button.

- The images will download. The  button will blink blue while downloading is in progress.
- The display will return to the Direct Transfer menu when the download is complete.
- Pressing the **FUNC./SET** button will cancel a download in progress.



Select & Transfer/Wallpaper

1. Use the **↑** or **↓** button to select  or  press the  button (or  button).

2. Use the **←** or **→** button to select images to download and press the button.

- The images will download. The  button will blink blue while downloading is in progress.



3. Press the button after downloading finishes.

- You will return to the Direct Transfer menu.



Only JPEG images can be downloaded as wallpaper for a computer.



The option selected with the  button is retained even when the camera's power is turned off. The previous setting will be in effect the next time the Direct Transfer menu is displayed. The image selection screen will appear directly when the [Select & Transfer] or the [Wallpaper] option was last selected.

Click [x] at the bottom right of the window to close CameraWindow, the downloaded images will display on the computer.

■ Windows



ZoomBrowser EX

■ Macintosh



ImageBrowser

By default, the downloaded images are saved into folders according to their shooting dates.

System Map

Supplied with Camera

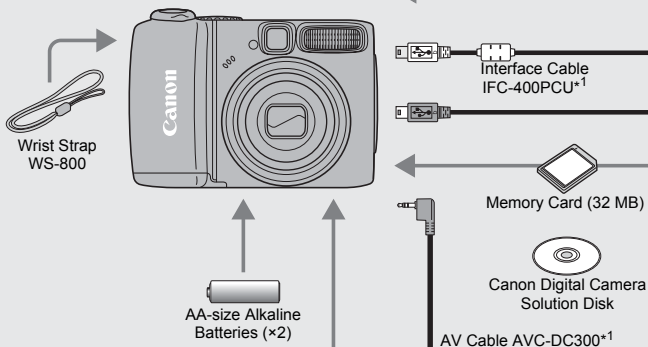

Battery and Charger Kit CBK4-300*4



- Battery Charger CB-5AH/CB-5AHE
- AA-size NiMH batteries NB-3AH (x4)
- NiMH Battery NB4-300 (set of 4 AA-size) also available separately.
- Two batteries are used for this camera.

AC Adapter Kit ACK800

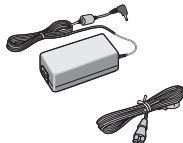

- Compact Power Adapter CA-PS800
- Power Cord

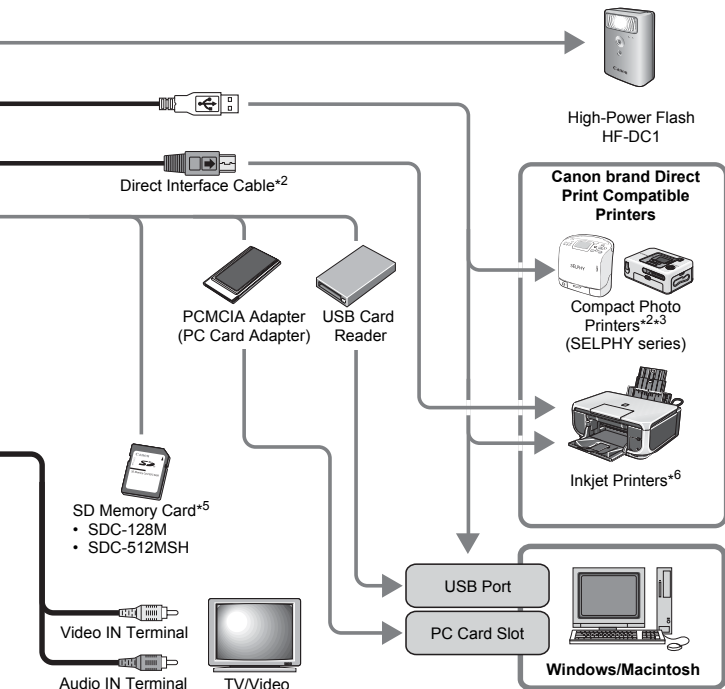

*1 Also available for purchase separately.

*2 See the user guide supplied with the printer for more information on the printer.

*3 This camera can also be connected to the Card Photo Printer CP-10/CP-100/CP-200/CP-300.

*4 Battery Charger CB-2LT/CB-2LTE may also be used.

*5 Not sold in some regions.

*6 See the user guide supplied with the inkjet printer for more information on the printer and interface cables.

Optional Accessories

The following camera accessories are sold separately. Some accessories are not sold in some regions, or may no longer be available.

Flash

- **High-Power Flash HF-DC1**

This attachable supplementary flash can be used to capture photographic subjects that are too distant for the built-in flash to illuminate.

Power Supplies

- **AC Adapter Kit ACK800**

This kit lets you power the camera from any standard household power outlet. Recommended to power a camera for an extended period of time or when connecting to a computer. (Cannot be used to charge the camera batteries.)

- **Battery and Charger Kit CBK4-300**

This dedicated battery charger kit includes both a charger unit and four rechargeable AA-size NiMH (nickel metal hydride) batteries. Convenient when taking or playing back large numbers of images. You can also purchase NiMH Battery NB4-300, a set of four rechargeable AA-size NiMH batteries separately.

Other Accessories

- **SD Memory Card**

SD memory cards are used to store images recorded by the camera. Canon brand cards are available in 128 MB and 512 MB capacities.

- **Interface Cable IFC-400PCU**

Use this cable to connect the camera to a computer, Compact Photo Printer (SELPHY series), or to a inkjet printer (refer to your inkjet printer user guide).

- **AV Cable AVC-DC300**

Use this cable to connect the camera to a TV set.

Use of genuine Canon accessories is recommended.

This product is designed to achieve excellent performance when used with genuine Canon accessories. Canon shall not be liable for any damage to this product and/or accidents such as fire, etc., caused by the malfunction of non-genuine Canon accessories (e.g., a leakage and/or explosion of a battery pack). Please note that this warranty does not apply to repairs arising out of the malfunction of non-genuine Canon accessories, although you may request such repairs on a chargeable basis.

Direct Print Compatible Printers

Canon offers the following separately sold printers for use with the camera. You can produce photo quality prints quickly and easily by connecting them to the camera with a single cable and operating the camera's controls.

- **Compact Photo Printers (SELPHY series)**
- **Inkjet Printers**

For more information, visit your nearest Canon retailer.

Learning More

Components Guide

■ Front View

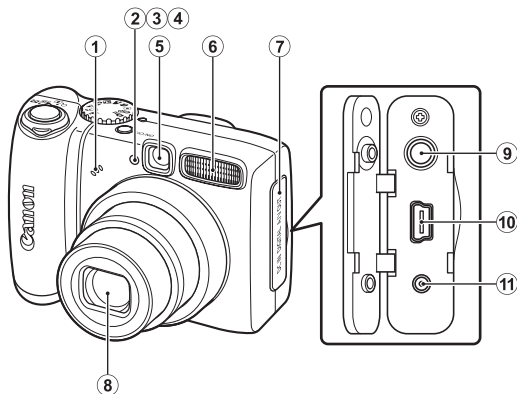

- ① Microphone (pp. 24, 122)
- ② AF-assist Beam (p. 49)
- ③ Red-Eye Reduction Lamp (p. 76)
- ④ Self-Timer Lamp (p. 61)
- ⑤ Viewfinder Window (p. 41)
- ⑥ Flash (p. 59)
- ⑦ Terminal Cover
- ⑧ Lens
- ⑨ AV OUT (Audio/Video output) Terminal (p. 141)
- ⑩ DIGITAL Terminal (p. 29)
- ⑪ DC IN (Power Input) Terminal (p. 170)

■ Back View

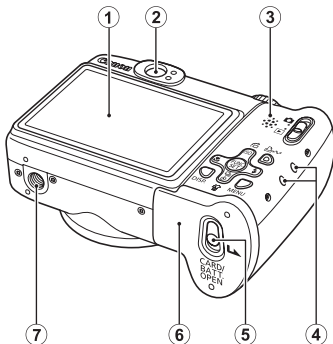

- ① LCD Monitor (p. 53)
- ② Viewfinder
- ③ Speaker
- ④ Wrist Strap Mount (p. 12)
- ⑤ Memory Card Slot / Battery Cover Lock (p. 10)
- ⑥ Memory Card Slot / Battery Cover (p. 10)
- ⑦ Tripod Socket

Using the Viewfinder

The viewfinder can be used to conserve power by turning the LCD monitor off (p. 53) while shooting.



The LCD monitor may be covered with a thin plastic film for protection against scratches during shipment. If so, remove the film before using the camera.

■ Controls

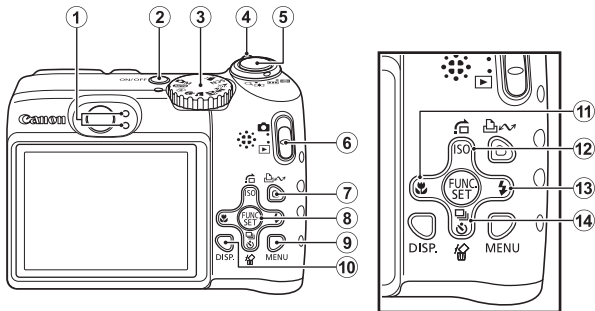

- ① Indicators (p. 43)
- ② ON/OFF button (p. 15)
- ③ Mode Dial (pp. 15, 66)
- ④ Zoom Lever (pp. 55, 103)
Shooting: (Wide Angle)/ (Telephoto)
Playback: (Index)/ (Magnify)
- ⑤ Shutter Button (p. 15)
- ⑥ Mode Switch (p. 18)
- ⑦ (Print/Share) Button (pp. 20, 31, 101)
- ⑧ **FUNC./SET** (Function/Set) Button (p. 44)
- ⑨ **MENU** Button (p. 45)
- ⑩ **DISP.** (Display) Button (p. 53)
- ⑪ (Macro)/ ← Button (p. 60)
- ⑫ (Jump)/ISO/ ↑ Button (pp. 65, 107)
- ⑬ (Flash)/ → Button (p. 59)
- ⑭ (Continuous)/ (Self-timer)/ (Single Image Erase)/
↓ Button (pp. 19, 61, 75)

Indicators

The camera indicators will light or blink under the following conditions.

• Upper Indicator

- Green : Ready to shoot (camera beeps twice)/when connected to a computer/when display off
- Blinking Green : Camera starting up/Image recording/reading/erasing/transferring (when connected to a computer or printer)
- Orange : Ready to shoot (flash on)
- Blinking Orange : Ready to shoot (camera shake warning/charging the flash)

• Lower Indicator

- Yellow: Macro mode/AF lock mode
- Blinking Yellow: Focusing difficulty (camera beeps once)



Never do the following while the indicator blinks green. These actions may corrupt image data.

- Shake or jolt the camera.
- Shut off the power, or open the memory card slot/battery cover.

Basic Operations





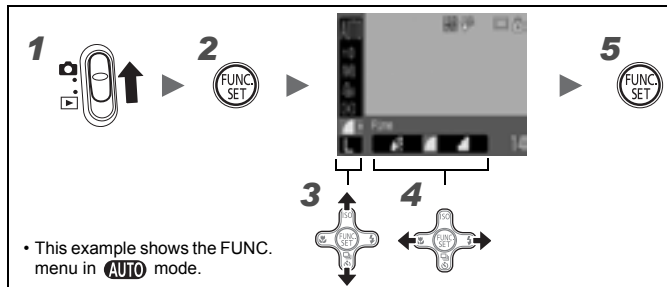

Menus and Settings

Settings for the shooting or playback modes or such camera settings as the print settings, date/time and sounds are set using the FUNC. menu or the Rec., Play, Print or Set up menu.

FUNC. Menu (**Button**)

This menu sets many of the common shooting functions.



- 1** Set the mode switch to  (shooting) and turn on the camera.
- 2** Press the  button.
- 3** Use the  or  button to select a menu item.
Some items may not be selectable in some shooting modes.
- 4** Use the  or  button to select an option for the menu item.
 - You can select further options with the **DISP.** button for some options.
 - After selecting an option, you can press the shutter button to shoot immediately. After shooting, the menu will appear again, allowing you to adjust the settings easily.
- 5** Press the  button.

Rec., Play, Print and Set up Menu (MENU Button)

Convenient settings for shooting, playback or printing can be set with these menus.

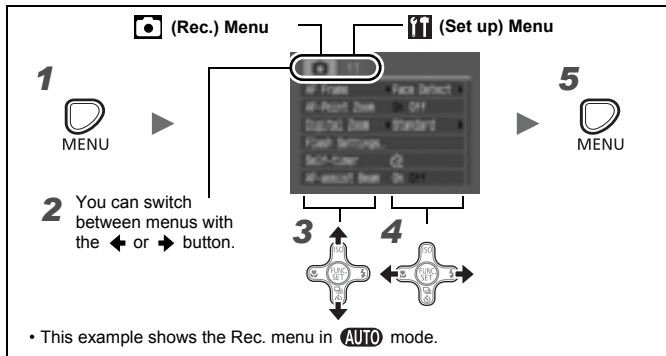

1 Press the MENU button.

2 Use the ← or → button to switch between menus.

- You can also use the zoom lever to switch between menus.
- The following menus are displayed.

Shooting: [Rec.] Rec./[Set up] Set up

Playback: [Play] Play/[Print] Print/[Set up] Set up

3 Use the ↑ or ↓ button to select a menu item.

- Some items may not be selectable in some shooting modes.

4 Use the ← or → button to select an option.

Menu items followed by an ellipsis (...) can only be set after pressing the **FUNC./SET** button to display the next menu. Press the **FUNC./SET** button again to confirm the setting and press the **MENU** button to return the menu screen.

5 Press the MENU button.

Information Displayed on the LCD Monitor and Menus

Available Shooting Modes >> p. 189

Shooting Mode

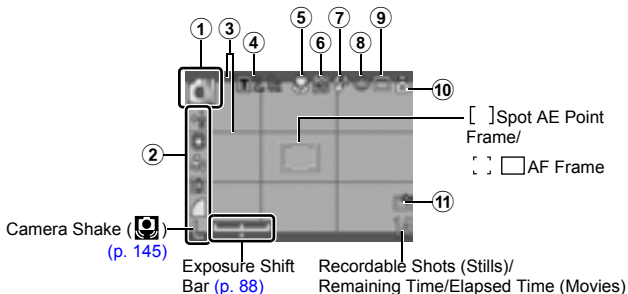









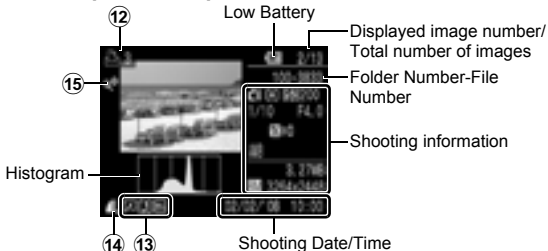









	Information Displayed	Setting Method
①	Shooting Mode	Mode dial
②	Exposure Compensation, Recording Pixels, etc.	FUNC./SET button (FUNC. menu)
③	Display Overlays	MENU button (Rec. menu)
④	Digital Tele-Converter (T 1.6x/2.0x)/ Digital Zoom Factor/ Safety Zoom (Z)	MENU button (Rec. menu)
⑤	Macro (M)	🌸 button
⑥	ISO Speed	ISO button
⑦	Flash (A, B, C)	⚡ button
⑧	Red-Eye Corr. (C)	MENU button ([Flash Settings] menu in the Rec. menu)
⑨	Drive Mode (S, C, R, Q, B)	📷 / 🔄 button
⑩	Auto Rotate (A, B, C)	MENU button (Setup menu)
⑪	Create Folder (F)	MENU button (Setup menu)

About the Battery Charge Indicator





When the battery charge is low,  will blink in red in the LCD monitor. Change the battery as soon as possible if you intend to use the camera for an extended period of time.

Playback Mode (Detailed)



	Information Displayed	Setting Method
12	Print List	  button, MENU button (Print menu)
13	Red-Eye Correction Function/ Resized image () Image with Sound Memo () Protection Status ()	MENU button (Play menu)
14	Compression (Still Images)/ Recording Pixels (Still Images), Movie ()	FUNC./SET button (FUNC. menu)
15	Auto Category (  ) My Category (       )	MENU button (Rec. menu) MENU button (Play menu)

The following information may also be displayed with some images.

	A file in a format other than the WAVE format is attached.
	JPEG image not conforming to Design rule for Camera File System Standards.
	RAW image
	Unrecognized data type



Information for images shot on other cameras may not display correctly.

Histogram Function

The histogram is a graph that allows you to check the brightness of an image. The greater the bias toward the left in the graph, the darker the image. The greater the bias toward the right, the brighter the image. By using the exposure compensation function, you can correct the image brightness before shooting (p. 90).

Sample Histograms



Dark Image



Balanced Image

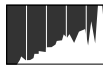

Bright Image

Shooting Mode















Item	Options	Reference Page
Still Image		pp. 15, 66
Movie		pp. 24, 71

FUNC. Menu

Menu	Item	Reference Page
Exposure Compensation	-2 ... +2	p. 90
White Balance	AWB, sun, cloud, moon, sunset, sunrise, and others	p. 94
My Colors	OFF, V, N, Se, BW, and others	p. 97
Metering Mode	☉, □, ●	p. 91
Compression	S, L, M	p. 64
Recording Pixels (Still Image)	L, M1, M2, M3, S, (when the date has not been set) W	p. 63
Recording Pixels (Movie)	1640, 1640, 320, 160	p. 74

* Default setting

Rec. Menu

Menu Item	Options	Reference Page
AF Frame	Face Detect*/AiAF/Center	p. 82
AF-Point Zoom	On/Off*	p. 78
Digital Zoom		
(Still Image)	Standard*/Off/1.6x/2.0x	p. 55
(Movies)	Standard*/Off (In standard movie mode only)	
Flash Settings	Slow Synchro	On/Off*
	Red-Eye Corr.	On/Off*
	Red-Eye Lamp	On*/Off
Self-timer	Delay: 0 – 10*, 15, 20, 30 sec. Shots: 1 – 10 (Default setting is 3 shots.)	p. 61
AF-assist Beam	On*/Off	p. 40
Review	Off/ 2* sec. to 10 sec./Hold	p. 16
Review Info	Off*/Detailed/Focus Check	p. 78
Auto Category	On*/Off	p. 100
Disp. Overlay		
(Still image)	Off*/Grid Lines/3:2 Guide/Both	p. 99
(Movie)	Off*/Grid Lines	
Set   button	 *           	p. 101

Play Menu

Menu Item	Reference Page
Slide Show	p. 114
My Category	p. 109
Red-Eye Correction	p. 115
Resize	p. 120
Sound Memo	p. 122
Protect	p. 124
Rotate	p. 112
Erase all	p. 125
Transfer Order	p. 130
Resume	p. 18
Transition	p. 113

Print Menu



Menu Item	Summary	Reference Page
Print	Displays the print menu.	–
Select Image & Qty.	Configures print settings for individual images as you view them.	p. 128
Select All Images	Configures print settings for all images.	
Clear All Selections	Removes all print settings from images.	
Print Settings	Sets the print style.	p. 126

Set up Menu

Menu Item	Options	Summary/Reference Page
Mute	On/Off*	Set to [On] to silence all operation sounds. (Except for when the memory card slot/battery cover is opened during recording.)
Volume	Off/ 1 / 2* / 3 / 4 / 5	Adjusts the volume of the start-up sound, operation sound, selftimer sound, shutter sound and playback sound. The volume cannot be adjusted if [Mute] is set to [On].
Start-up Vol.		Adjusts the volume of the start-up sound when the camera is turned on.
Operation Vol.		Adjusts the volume of the operation sound that beeps when any button other than the shutter button is pressed.
Selftimer Vol.		Adjusts the volume of the selftimer sound played 2 sec. before the shutter is released.
Shutter Volume		Adjusts the volume of the sound played when the shutter releases. The shutter sound does not play when a movie is recording.
Playback Vol.		Adjusts the volume of movie sounds or sound memos.
Start-up Image	On*/Off	Sets whether or not the Start-up Image appears when the camera is powered on.
Power Saving		p. 132
Auto Power Down	On*/Off	
Display Off	10 sec./20 sec./30 sec./1 min.*/ 2 min./ 3 min.	
Date/Time		p. 13

Menu Item	Options	Summary/Reference Page
Format		You can also select a low level format (p. 134).
File Numbering	Continuous*/ Auto Reset	p. 135
Create Folder		p. 137
Create New Folder	Check mark (On)/ No check mark (Off)	
Auto Create	Off*/Daily/Monday- Sunday/Monthly (Creation time also can be set)	
Auto Rotate	On*/Off	p. 139
Lens Retract	1 minute*/0 seconds	Sets the lens retraction timing when switching from shooting mode to playback mode.
Language		p. 14
Video System	NTSC/PAL	p. 141
Print Method	Auto*/ 	See below.
Reset All		p. 140

Print Method

The connection method with the printer can be changed for printing. Although it is normally not necessary to change the setting, select  when borderless printing an image shot in  (Widescreen) mode on wide size paper using Canon compact photo printer SELPHY CP750/CP740/CP730/CP720/CP710/CP510/CP520. As this setting will be stored to memory even when the power is turned off, to print using an image size other than , return the mode to [Auto] (however, the connection method cannot be changed while connected to a printer).

Using the LCD Monitor

Switching LCD Monitor Display Modes

Each press of the **DISP.** button, changes the display mode of the LCD monitor. See *Information Displayed on the LCD Monitor and Menus* for details (p. 46).

The following are the screens that display when shooting in **AUTO** mode.

■ Shooting Mode

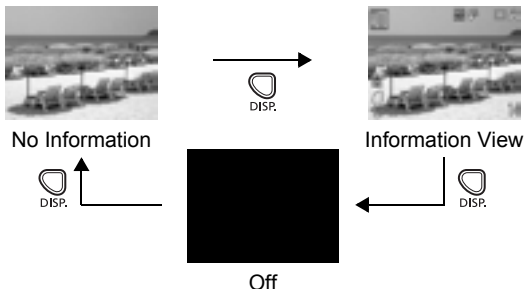

■ Playback Mode or Rec. Review (Right After Shooting)

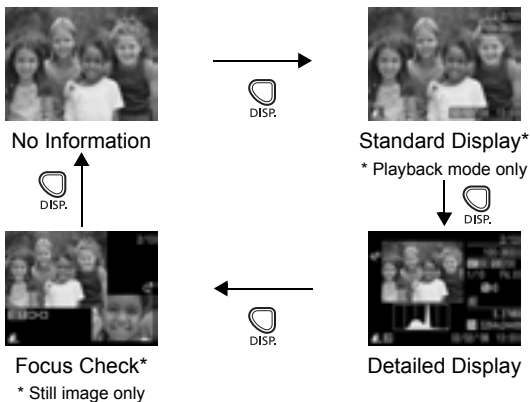



- The LCD monitor will not switch to the detailed display or focus check display in magnified display (p. 103), or index playback mode (p. 104).
- Overexposure Warning
In the following cases, overexposed portions of the image blink.
 - When reviewing an image right after shooting in the LCD monitor (detailed display)
 - When using the detailed display mode of the playback mode

Night Display

When shooting at dusk or during the evening when the dark surroundings make it difficult to view the LCD monitor, the camera's "night view" option* displays the subject brightly in the LCD monitor. This will allow you to compose a shot even in dark environments (this setting cannot be turned off).



* Although noise may appear and the movement of the subject shown on the LCD monitor may appear somewhat jagged, there is no effect on the recorded image. The brightness of the image displayed in the monitor, and the brightness of the actual image recorded will be different.

Commonly Used Shooting Functions

Using the Optical Zoom

The zoom can be adjusted from 35 – 140 mm (focal length) in 35mm film equivalent terms. The zoom bar appears when you press the zoom lever.

1 Press the zoom lever toward or .

-  Telephoto: Zooms in on the subject.
-  Wide Angle: Zooms out from the subject.

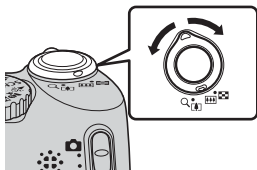

Using the Digital Zoom/ Digital Tele-Converter

Available Shooting Modes >> [p. 189](#)

You can combine digital zoom with optical zoom when shooting. The available shooting characteristics and focal lengths (35mm film equivalent) are as follows.

Selection	Focal Length	Shooting Characteristics
Standard	35 – 560 mm	Enables shooting at zoom factors of up to 16x with digital and optical zoom combined.
Off	35 – 140 mm	Enables shooting without digital zoom.
1.6x	56 – 224 mm	Digital zoom is fixed at the selected zoom factor, and the focal length shifts to maximum telephoto.
2.0x	70 – 280 mm	This enables a faster shutter speed and less chance of camera shake than a shot taken at the same angle of view with [Standard] or [Off].

About the Safety Zoom

Depending on the number of recording pixels set, you can shift from optical zoom to digital zoom without pausing up to a factor where the image quality does not deteriorate (Safety Zoom).  displays when reaching the maximum zoom factor without image deterioration.

Pressing the zoom lever toward  again allows you to zoom even further (not available in ).



Depending on the number of recording pixels set, the Safety Zoom zone varies as follows.

Safety Zoom Factor

Recording pixels	Optical zoom	Digital zoom
L	4.0x	
M1	5.0x	
M2	6.4x	
M3	8.2x	
S		16x



  : Zone without deterioration  : Zone with deterioration



- The digital zoom cannot be used when the LCD monitor is turned off.
- The digital zoom cannot be used in  (Date Stamp) or  (Widescreen) modes.



Shooting with the Digital Zoom

1 Select [Digital Zoom].

1. Press the  button.
2. In the  menu, use the  or  button to select [Digital Zoom].



2 Make settings.

1. Use the  or  button to select [Standard].
2. Press the  button.

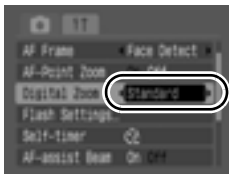

3 Press the zoom lever toward and shoot.

- The combined digital and optical zoom setting will display in the LCD monitor.
- The image may appear coarse depending upon the selected recording pixels (the zoom factor appears in blue).
- Press the zoom lever toward  to zoom out.



Shooting with the Digital Tele-Converter



The digital tele-converter feature uses digital zoom to achieve the effects of a tele-converter (a lens used in telephoto shooting).

1 Select [Digital Zoom].

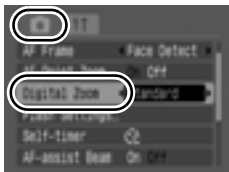
1. Press the  button.
2. In the  menu, use the  or  button to select [Digital Zoom].



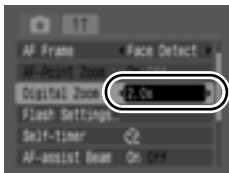

2 Make settings.

1. Use the  or  button to select [1.6x] or [2.0x].
2. Press the  button.



3 Adjust the angle of view with the zoom lever and shoot.

-  and the zoom factor appear on the LCD monitor.
- The image may appear coarse depending upon the selected recording pixels (the  icon and the zoom factor appear in blue).



⚡ Using the Flash



Available Shooting Modes >> p. 189

1 Press the ⚡ button.

1. Use the ◀ or ▶ button to select the flash settings.

⚡A : [Auto]

⚡ : [On]

⊗ : [Off]



- You can configure detailed settings for the flash when you press the **MENU** button while this screen is displayed (p. 76).



You are recommended to shoot with the camera attached to a tripod or other device if the camera shake warning icon (📷) appears.

Shooting Close-ups (Macro)



Available Shooting Modes >> p. 189



Use this mode to shoot close-ups of flowers or small items. The image area at the minimum shooting distance from the end of the lens to the subject (5 cm) (2.0 in.) is 59 × 44 mm (2.3 × 1.7 in.).

1 Press the button.

1. Use the ← or → button to select .



To Cancel the Macro Mode:

Press the  button and use the ← or → button to select  (Normal).



- Use the LCD monitor to compose close-ups in macro mode since the view through the viewfinder may not match the image taken.
- Using the flash in macro mode may cause image edges to darken.

🕒 Using the Self-Timer



Available Shooting Modes >> p. 189

You can set the time delay and the numbers of shots you wish to take in advance.

	<p>10 sec. Self-Timer: The shutter releases 10 seconds after the shutter button is pressed.</p> <ul style="list-style-type: none"> • 2 seconds before the shutter releases, the self-timer sound beeps quickly and the lamp will speed up.
	<p>2 sec. Self-Timer: The shutter releases 2 seconds after the shutter button is pressed.</p> <ul style="list-style-type: none"> • The self-timer sound beeps quickly and the self-timer lamp blinks when the shutter button is pressed and the shutter releases 2 seconds later.
	<p>Custom Timer: You can change the delay time (0 – 10, 15, 20, 30 sec.) and number of shots (1 – 10).</p> <ul style="list-style-type: none"> • When a delay time of over 2 seconds is set for the [Delay] option, the self-timer sound beeps quickly 2 seconds before the shutter releases. If multiple shots have been specified for the [Shots] option, the sound will play for the first shot only.

1 Select the self-timer mode.

1. Press the 🕒 button.
2. Use the ⬆ or ⬇ button to change the self-timer mode.
 - When this screen displays, pressing the **MENU** button will allow you to set the custom self-timer (p. 62).



2 Shoot.

- When you press the shutter button fully, the self-timer lamp will blink.*

* When [Red-Eye Lamp] is set to [On] in [Flash Settings] in the Rec. menu, the self-timer lamp will light 2 seconds before the flash fires (p. 76).

To Cancel the Self-Timer:

Press the  button and the  or  button to select .





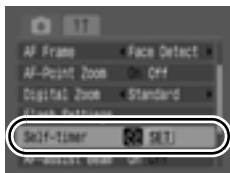

Changing the Delay Time and Number of Shots (🕒)

1 Select [Self-timer].

1. Press the  button.
2. In the  menu, use the  or  button to select [Self-timer].
3. Press the  button.



2 Make settings.

1. Use the  or  button to select [Delay] or [Shots] and the  or  button to change the settings.
2. Press the  button.
3. Press the  button.

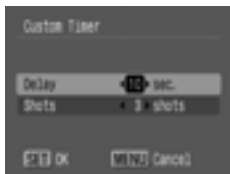

If the [Shots] option is set to 2 or more shots, the following occurs.

- The exposure and white balance are locked at the settings selected for the first shot.
- If the flash is used, the interval between shots lengthens.
- The interval between shots may lengthen when the built-in memory of the camera fills.
- Shooting will automatically cease if the memory card becomes full.

Changing the Recording Pixels (Still Images)



Available Shooting Modes >> p. 189

1 Select the recording pixels.

1. Press the button.
2. Use the or button to select **L** and the or button to change the recording pixels.
3. Press the button.



Approximate Values for Recording Pixels

Recording Pixels			Purpose*
Large	8M	3264 × 2448	High Low
Medium 1	5M	2592 × 1944	
Medium 2	3M	2048 × 1536	
Medium 3	2M	1600 × 1200	
Small	0.3M	640 × 480	
Date Stamp	2M	1600 × 1200	
Widescreen		3264 × 1832	Printing on wide size paper (you can check the composition at a 16:9 aspect ratio. Areas that will not be recorded appear on the LCD monitor as a black border.)

: Approximate recording pixel numbers are shown. (M is short for megapixels.)

* Paper sizes vary according to region.









- See *Memory Cards and Estimated Capacities* (p. 181)
- See *Image Data Sizes (Estimated)* (p. 182)

Changing the Compression (Still Images)





Available Shooting Modes >> p. 189

1 Select a compression setting.

1. Press the  button.
2. Use the  or  button to select  and the  or  button to change the option.
3. Press the  button.



Approximate Values for Compression Settings

Compression		Purpose
 Superfine	High Quality	Shoot higher quality images.
 Fine	  Normal	Shoot normal quality images.
 Normal		Shoot more images.



- See *Memory Cards and Estimated Capacities* (p. 181)
- See *Image Data Sizes (Estimated)* (p. 182)

ISO Adjusting the ISO Speed



Available Shooting Modes >> p. 189

Raise the ISO speed to use a fast shutter speed when you wish to reduce the effects of camera shake or avoid blurry subjects, or to turn the flash off when shooting in a dark area.

1 Press the **ISO** button.

1. Use the **↑** or **↓** button to change the ISO speed.

- When you select **ISO AUTO** (Auto) or **ISO HI** (High ISO Auto), the camera sets the optimal ISO speed for the light level when shooting. As the ISO speed will automatically be raised in dark places, shutter speed will increase, reducing camera shake and subject blurring.
- Select **ISO AUTO** to put priority on image quality.
- When you select **ISO HI**, the camera also detects motion and sets the optimum ISO speed. As the shutter speed becomes even faster*, camera shake and blurred photos caused by subject movement will be reduced even more than when shooting the same scene in Auto.

* Noise may increase in the captured image compared to **ISO AUTO**.

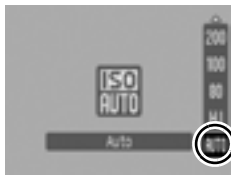

- The camera automatically applies noise reduction processing when you shoot at a high ISO speed.
- If the camera is set at **ISO AUTO** or **ISO HI**, the ISO speed automatically set by the camera will be displayed when pressing the shutter button halfway or in playback information.

Shooting Using the Mode Dial

Mode Dial

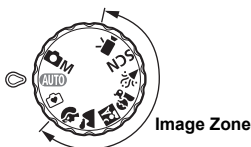

The camera automatically selects settings.

AUTO : Auto (p. 15)

: Easy (p. 17)

■ Image Zone

When a shooting mode appropriate for the shooting conditions is selected, the camera automatically adjusts settings for optimal shooting.

: Portrait

: Landscape

: Night Snapshot

: Kids&Pets

: Indoor

SCN : Special Scene (p. 67)

: Night Scene

: Sunset

: Foliage

: Snow

: Beach

: Fireworks

: Aquarium

: Movie (pp. 24, 71)

Allows you to select settings yourself, such as the exposure compensation, white balance or My Color settings.

M : Manual (p. 70)

Shooting Modes for Specific Scenes

Available Shooting Modes >> p. 189







When a shooting mode appropriate for the shooting conditions is selected, the camera automatically adjusts settings for optimal shooting.

, , , , or SCN (Special Scene)

1 Set the mode dial to , , , , or SCN.



SCN :

1. Press the  button.
2. Use the  or  to select  and the  or  to select the scene mode.
3. Press the  button.



Portrait

Produces a soft effect when photographing people.



Landscape

Optimized for shooting landscape scenes which contain both near and far subjects.

** Night Snapshot**

Allows you to take snapshots of people against twilight or night backgrounds by reducing the effects of camera shake when firmly holding the camera, even without using a tripod.

** Kids&Pets**

Allows you to capture subjects that move around, such as children and pets, without missing photo opportunities.

** Indoor**

Prevents camera shake and maintains the subject's true color when shooting under fluorescent or tungsten lighting.

** Night Scene**

Allows you to capture people against the backdrop of an evening sky or night scene. The flash is directed at the person and the shutter speed is slow, so both the person and the background can be beautifully shot.

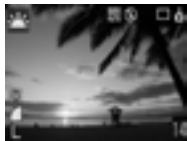
** Sunset**

Allows you to shoot sunsets in vivid colors.

** Foliage**

Shoots trees and leaves - such as new growth, autumn leaves or blossoms - in vivid colors.



Snow

Shoots without a blue tinge and without making people appear dark against a snowy background.



Beach

Shoots without making people appear dark near water or sand where reflected sunlight is strong.



Fireworks







Captures fireworks in the sky sharply and at optimal exposure.



Aquarium

Selects the optimal ISO speed, white balance and color balance to capture fish and other items in an indoor aquarium.



- The shutter speed is slow in  or  mode. Always use a tripod to avoid camera shake.
- In , ,  or  mode, the ISO speed may increase and cause noise in the image depending on the scene being shot.

Movie Shooting



Available Shooting Modes >> p. 189

The following movie modes are available.

The recording time will differ according to the memory card used (p. 182).

Standard

You can select the recording pixels and record until the memory card is full*1.

The digital zoom can be used while shooting in this mode (p. 55).

- Maximum Size: 4 GB/movie*2

Compact

Since there are few recording pixels and also the data size is small, this mode is convenient for sending movies as e-mail attachments or when the memory card capacity is low.

- Maximum Clip Length: 3 minutes







*1 When a super high-speed memory card is used, such as the recommended SDC-512MSH.

*2 Even if the file size has not reached 4 GB, the recording is stopped when the recording time reaches one hour. Depending on memory card capacity and data write speed, recording may stop before the file size reaches 4 GB or the recording time reaches one hour.

1 Set the mode dial to .



2 Select a movie mode.

1. Press the  button.
2. Use the  or  to select  and the  or  to select the movie mode.
3. Press the  button.



3 Shoot.

- Pressing the shutter button halfway automatically sets the exposure, focus and white balance settings.
- Pressing the shutter button fully starts recording video and sound simultaneously.
- During shooting, the recording time and [●Rec] appear on the LCD monitor.
- Pressing the shutter button fully again stops recording. Recording will stop automatically under the following circumstances.
 - When the maximum recording time or maximum recording capacity is reached.
 - When the built-in memory or memory card becomes full



- You are recommended to use a memory card that has been formatted in your camera to shoot movies (p. 134). The card supplied with the camera may be used without further formatting.
- Be careful of the following while recording.
 - Try not to touch the microphone (p. 40).
 - Do not press any buttons other than the shutter button. The sound that buttons make will be recorded in the movie.
 - The camera will automatically adjust the exposure and white balance to suit the shooting conditions during a recording. Please note, however, that the sounds made by the camera while automatically adjusting the exposure may also be recorded.
- The focus and optical zoom settings remain fixed for subsequent frames at the values selected for the first frame.









- Adjust the zoom setting before shooting. The combined digital and optical zoom factor will display on the LCD monitor. When the zoom factor displays in blue, the image will deteriorate.
- You can use digital zoom during the movie shooting in  mode only.
- QuickTime is required to play back movies (Data type: AVI/ Compression method: Motion JPEG) on a computer (Windows 2000 only).

Changing Movie Recording Pixels/Frame Rates

You can change the recording pixels and frame rate when the movie mode is set to  (Standard). The frame rate can be set depending on the recording pixels.





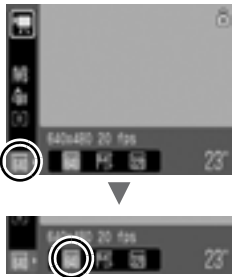

1 Select the recording pixels.

1. Press the  button.
2. Use the  or  button to select  and the  or  button to change the recording pixels.
3. Press the  button.



Movie Recording Pixels and Frame Rates

Frame rates indicate the number of frames recorded or played back each second. The higher the frame rate, the smoother the appearance of motion.

 Standard	 *1	640 × 480 recording pixels, 20 frames/sec.
	 *2	640 × 480 recording pixels, 20 frames/sec. LP
 Compact		320 × 240 recording pixels, 30 frames/sec.
		160 × 120 recording pixels, 15 frames/sec.

*1 Default setting.

*2 When priority is on movie length rather than image quality, select . You can shoot for twice as long in this mode compared to a file of the same size shot in the other modes.



- See *Memory Cards and Estimated Capacities* (p. 182).
- See *Image Data Sizes (Estimated)* (p. 182)

Advanced Shooting Functions

Continuous Shooting

Available Shooting Modes >> p. 189

In this mode, the camera shoots continuously while the shutter button is held down.



If you use the recommended memory card*, you can shoot continuously (smooth continuous shooting) at a set shooting interval until the memory card is full (p. 181).

*Recommended Memory Card:

Super high-speed SDC-512MSH memory card (sold separately) to which low-level formatting (p. 134) is conducted immediately before shooting.

- Except  (Large/Super Fine) mode.
- This reflects standard shooting criteria established by Canon. Actual results may vary according to the subject and shooting conditions.
- Even if continuous shooting suddenly stops, the memory card may not be full.

1 Press the button.

1. Use the  or  button to select .



2 Shoot.

- The camera will continue to record successive images while the shutter button is held down. Recording will cease when the shutter button is released.

To Cancel Continuous Shooting:

Follow Step 1 to select .



- The interval between shots lengthens when the built-in memory of the camera fills.
- If the flash is used, the interval between shots lengthens because the flash must charge.

Setting the Flash



Available Shooting Modes >> p. 189

You can make detailed flash settings to fit the shooting conditions.

Flash Settings

Slow Synchro	The flash is used with slow shutter speeds to shoot. This reduces the chance that only the background will appear dark when a night scene or an interior shot is taken with the flash.	Using Slow Synchro increases the chances for camera shake. Use of a tripod is recommended.
Red-Eye Corr.	Automatically searches for and corrects red eyes in the image when the flash fires.	—
Red-Eye Lamp	This feature reduces the effect of light reflecting back from the eyes and making them appear red.	When set to [On], the red-eye reduction lamp lights orange before the flash fires.



About Red-Eye Correction

- When [Red-Eye Corr.] is set to [On], only the corrected image is recorded to the memory card.
- If the area around the eyes is red, for example from using red eye shadow, that area may also be corrected. If this happens, set [Red-Eye Corr.] to [Off].
- Red eyes may not be automatically detected or may not be fully corrected on some images. In either case, you can correct images with [Red-Eye Correction] in the  menu (p. 115).



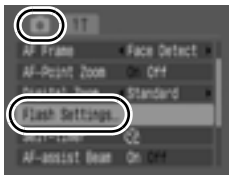

Displaying and Setting [Flash Settings]

1 Select [Flash Settings].

1. Press the  button.
2. In the  menu, use the  or  button to select [Flash Settings].
3. Press the  button.



2 Make settings.

1. Use the  or  to select the option.
2. Use the  or  button to make the setting.
3. Press the  button.

Example in Av mode

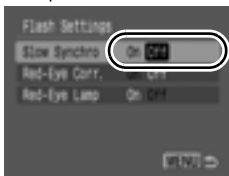

3 Press the button.



[Flash Settings] can also be displayed by pressing the  button, followed by the **MENU** button.

Checking the Focus and Peoples' Expressions



Available Shooting Modes >> p. 189

You can zoom the display of the AF frame to check focus when shooting or right after taking a shot.

Zooming the AF Frame and Shooting

When [AF Frame] is set to [Face Detect] or [Center], the AF frame area can be zoomed to check focus while shooting. When you want to capture people's expressions, set [AF Frame] to [Face Detect]. When you want to check the focus while shooting in macro mode, set [AF Frame] to [Center].

1 Select [AF-Point Zoom].

1. Press the  button.
2. In the  menu, use the  or  button to select [AF-Point Zoom].



2 Make settings.

1. Use the  or  button to select [On].
2. Press the  button.



3 Press the shutter button halfway.

- Pressing the shutter button halfway zooms a section of the display according to the following AF Frame mode settings (p. 82).
 - [Face Detect] : The face detected as the main subject will appear zoomed.
 - [Center] : The center of the image will appear zoomed in the LCD monitor.

4 Press the shutter button fully to shoot.



The AF frame cannot be zoomed under the following circumstances:



- When [AF Frame] is set to [Face Detect] and a face is not detected, or when the face is extremely large in relation to the overall composition.
- When the camera cannot focus.
- When the digital zoom is in use.
- When the LCD monitor is off.
- When a TV is being used as the display.

Checking Focus Right After Shooting (Focus Check)

Allows you to check the focus of an image taken. It is also easy to check peoples' expressions and look for closed eyes when shooting because a frame the size of the face displays when AF frame mode is set to [Face Detect] (p. 82).



You are recommended to set [Review] to [Hold] in the  menu in advance.

1 Select [Review Info].

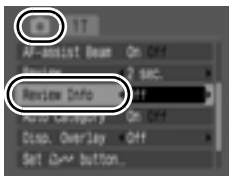
1. Press the  button.
2. In the  menu, use the  or  button to select [Review Info].



2 Make settings.

1. Use the  or  button to select [Focus Check].
2. Press the  button.

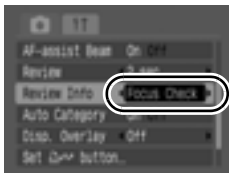

3 Shoot.

- The recorded image will be displayed.

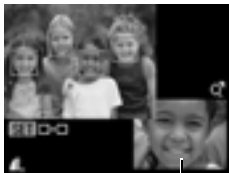

Orange frame contents

- Frames are displayed as follows.

Frame color	Content
Orange	Displays the area of the image shown at the bottom right.
White	Displays at the focal point (AF frame).

- The orange frame can be shown at a different magnification, moved or switched to a different frame (p. 106).

To Cancel the Focus Check:

Press the shutter button halfway.







- Pressing the  button while the image is displayed will erase the image (p. 19).
- You can check the focus even during playback mode (p. 105).

Selecting an AF Frame Mode

Available Shooting Modes  p. 189

The AF frame indicates the area of the composition on which the camera focuses.



	Face Detect	<p>The camera detects a face and sets the focus, exposure*¹ and white balance*². In addition, the camera meters the subject so that the face is correctly illuminated when the flash fires. If no face is detected, the camera shoots using [AiAF].</p> <p>*1 Only in evaluative metering mode (p. 91). *2 Only in  (p. 94).</p>
	AiAF	<p>The camera automatically selects between 9 AF frames to focus on according to the shooting conditions.</p>
	Center	<p>The AF frame will be fixed to center. This is recommended when the target subject is at the center of the composition.</p>

1 Select [AF Frame].

1. Press the  button.
2. In the  menu, use the  or  button to select [AF Frame].



2 Make settings.

1. Use the  or  button to select [Face Detect], [AiAF] or [Center].
2. Press the  button.





- [Face Detect] cannot be used when the LCD monitor is turned off.
- The AF frame appears as follows when the shutter button is pressed halfway.
 - Green : In focus
 - Yellow : Focusing difficulty ([Center] option)
 - No AF frame : Focusing difficulty ([Face Detect] or [AiAF] option)

Face Detect Feature

- Maximum of three AF frames will be displayed at the positions of faces the camera recognizes. At this point, the frame the camera judges to be the main subject appears in white while the others appear in gray. When the shutter button is pressed halfway and the camera focuses, up to 9 green AF frames may appear.
- The camera will shoot using [AiAF] not the [Face Detect] function if a white frame fails to appear and only gray frames display, or if a face is not detected.
- The camera may mistakenly identify non-human subjects as a face.
- In certain cases, faces may not be detected.
Examples:
 - If faces are at the edge of the screen, or appear extremely small, large, dark or bright, relative to the overall composition.
 - Faces turned to the side or at a diagonal, or faces with a portion hidden.

Selecting a Subject to Focus On (Face Select and Track)



Available Shooting Modes >> p. 189

Once the focus is fixed to a subject's face, the frame can be set to follow the subject within a certain range.



To use the Face Select and Track function, first configure the following settings.

- Set [AF Frame] to [Face Detect] (p. 82).
- Register the (Face Detect) function to the button (p. 101).

1 Select a face you wish to focus on.

1. When a face is detected, press the button.

- The camera enters face designation mode, and the face frame () of the main subject displays in green. Even if the subject moves, the frame will follow the subject within a certain range.



2. Select the person you wish to focus on.

- When several faces have been detected, pressing the or button will move the face frame to another subject.
- The face frame will not display when a face is not detected.
- Holding down the **DISP.** button will display face frames (up to 35) of all the detected faces (green: face of main subject, white: detected faces).
- Pressing the button will release the face designation mode.





3. Press the  button again.

- The camera exits face designation mode, and the face frame () of the main subject will change to white (the frame will continue to follow the subject within a certain range).



2 Press the shutter button halfway.

- The face frame () of main subject will change into .

3 Press the shutter button fully to shoot.



In the following cases, the face select mode will be canceled.

- When turning the power back on
- Using the digital zoom
- When the  button is pressed to display the menu
- When a selected face cannot be tracked for several seconds
- When the display is turned off

Shooting Hard-to-Focus Subjects (Focus Lock, AF Lock)



Available Shooting Modes >> p. 189

It may be difficult to focus on the following types of subjects.

- Subjects with extremely low contrast to the surroundings
- Scenes with a mixture of near and far subjects
- Subjects with extremely bright objects at the center of the composition
- Subjects that are moving quickly
- Subjects through glass

When this happens, first lock the focus and then recompose the shot.

Shooting with the Focus Lock

Pressing the shutter button halfway locks the focus.

- 1 Aim the camera so that an object at the same focal distance as the main subject is centered in the viewfinder or in the AF frame displayed on the LCD monitor.**
- 2 Keep the shutter button pressed halfway while you recompose the image.**
- 3 Press the shutter button fully to shoot the image.**

Shooting with the AF Lock

You can release the shutter button while recomposing the shot.

- 1 Turn on the LCD monitor.**
- 2 Aim the camera so that an object at the same focal distance as the main subject is centered in the AF frame.**

3 Press the shutter button halfway and press the button.

-  will display.

4 Recompose the image and press the shutter button fully.

To Release the AF Lock:

Press the  button.



- When shooting with the focus lock or AF lock using the LCD monitor, setting [AF Frame] to [Center] (p. 82) makes shooting easier since the camera focuses using the center AF frame only.
- AF frames do not display in  mode.
- Try to shoot as close to the glass as possible to reduce the chances of light reflecting back off the glass when you shoot a subject through glass.

Locking the Exposure Setting (AE Lock)

Available Shooting Modes  p. 189





You can set the exposure and focus separately. This is effective when shooting on ski slopes, beaches and other scenes where there is an extremely strong contrast between the background and a backlit subject, or a mix of bright and dark areas. You can set an exposure that best matches the shot you wish to take.

1 Turn on the LCD monitor.





2 Focus the camera on the subject on which you wish to lock the exposure setting.

3 Lock the exposure and shoot.

Still Images:

1. Press the  button to select  (Off).
2. Press the shutter button halfway and press the  button.
 - The exposure is locked and  displays.
3. Re-aim the camera to compose the shot as desired, and press the shutter button fully.
 - To release the AE lock, press the  button again.

Movies:

1. Press the  button.
 - The exposure is locked (AE lock) and the exposure shift bar appears.
2. Use the  or  button to change the exposure and shoot.
 - To release the AE lock, press the  button again. Pressing the **MENU** button or changing the white balance settings, My Colors settings or the shooting mode, also releases the AE lock.







Use the FE lock to shoot when you want to use the flash.

Shooting with FE Lock

Available Shooting Modes >> p. 189

You can use FE lock to set the flash output for the best exposure of your subject regardless of the composition of the shot.

- 1 Turn on the LCD monitor.**
- 2 Press the  button to select  (On).**
- 3 Focus the camera on the subject on which you wish to lock the exposure setting.**
- 4 Press the shutter button halfway and press the  button.**
 -  will display.
- 5 Re-aim the camera to compose the shot and shoot.**

To Release the FE Lock:

Press the  button.







Adjusting the Exposure Compensation (Still Images)



Available Shooting Modes >> p. 189

Adjust the exposure compensation to a positive value to avoid making the subject too dark when it is backlit or shot against a bright background. Adjust the exposure compensation to a negative value to avoid making the subject too bright in night shots or when shot against a dark background.

1 Adjust the exposure compensation.

1. Press the  button.
2. Use the  or  button to select  and the  or  button to adjust the exposure compensation.
3. Press the  button.



To Cancel the Exposure Compensation:



Restore the compensation value to [0].









Exposure shift is used to change the exposure when shooting movies (p. 88).

Switching between Metering Modes

Available Shooting Modes >> p. 189

	Evaluative	Appropriate for standard shooting conditions, including backlit scenes. The camera divides images into several zones for metering. It evaluates complex lighting conditions, such as the position of the subject, the brightness, the direct light, and the backlighting, and adjusts the settings to the correct exposure for the main subject.
	Center Weighted Avg.	Averages the light metered from the entire frame, but gives greater weight to the subject matter at the center.
	Spot	Use when there is a large variance in brightness between the subject and the surroundings. Sets the exposure to suit the subject at the center of the composition.

1 Change the metering mode.

1. Press the  button.
2. Use the  or  button to select  and the  or  button to change the option.
3. Press the  button.







Setting a Slow Shutter Speed (Long Shutter Mode)



Available Shooting Modes >> p. 189



You can set the shutter speed to a slow setting to make dark subjects appear brighter.

1 Select the Long Shutter Mode.

1. Press the  button.
2. Use the  or  button to select .
3. Press the  button.



2 Adjust the setting.

1. Use the  or  button to change the shutter speed.
2. Press the  button.
 - The higher the value, the brighter the recorded image becomes.
 - If you press the **DISP.** button at this point, you will return to the Exposure Compensation setting screen.

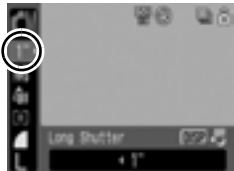

- The brightness of the image appearing on the LCD monitor and the recorded image may differ.
- The nature of CCD image sensors is such that noise in the recorded image increases at long shutter speeds. This camera, however, applies special processing to images shot at shutter speeds of 1.3 seconds or slower to eliminate the noise, thereby producing high-quality images. A certain amount of processing time, however, may be required before the next image can be shot.



- Use the LCD monitor to confirm that the image was recorded at the desired brightness.
- Please note that camera shake becomes a factor at low shutter speeds. Shoot with the camera attached to a tripod.
- Use of the flash may result in an over-exposed image. If this occurs, shoot with the flash set to

Adjusting the Tone (White Balance)



Available Shooting Modes >> p. 189

Normally, the **AWB** (Auto) white balance setting selects an optimal white balance. When the **AWB** setting cannot produce natural looking colors, change the white balance using a setting appropriate for the light source.

	Auto	Settings are automatically set by the camera.
	Day Light	For recording outdoors on a bright day.
	Cloudy	For recording under overcast, shady or twilight skies.
	Tungsten	For recording under tungsten and bulb-type 3-wavelength fluorescent lighting.
	Fluorescent	For recording under warm-white, cool-white or warm-white (3-wavelength) fluorescent lighting.
	Fluorescent H	For recording under daylight fluorescent, or daylight fluorescent-type 3-wavelength fluorescent lighting.
	Custom	For recording with the optimal white balance data memorized in the camera from a white-colored object, such as white paper or cloth.



1 Select a white balance setting.

1. Press the button.
2. Use the or button to select **AWB** and the or button to change the option.
3. Press the button.









The white balance setting cannot be adjusted when **ASc** or **ABW** is selected for My Colors.

Using the Custom White Balance

Take a custom white balance  (Custom) reading for the following situations that are difficult for the  (Auto) setting to detect correctly.

- Shooting subjects of monotone color (such as sky, sea or forest)
- Shooting with a particular source of light (such as a mercury-vapor lamp)
- Shooting close-ups (Macro)

1 Select .

1. Press the  button.
2. Use the  or  button to select  and use the  or  button to select .







2 Aim the camera at a piece of white paper or cloth and press the button.

- Ensure that the LCD monitor is completely filled with the white image. Please note, however, that the center frame will not display when the digital zoom is used or when  is displayed.
- You can also use the viewfinder to take a custom white balance reading.



3 Press the button.









- You are recommended to set the shooting mode to  and the exposure compensation setting to $[\pm 0]$ before setting a custom white balance. The correct white balance may not be obtained when the exposure setting is incorrect (image appears completely black or white).
- Shoot with the same settings as when reading the white balance data. If the settings differ, the optimal white balance may not be set. In particular, the following should not be changed.
 - ISO speed
 - Flash:
Setting the flash to  or  is recommended. If the flash fires when reading the white balance data with the flash set to , make sure that you also use the flash when you shoot.
- The white balance data is retained even after the camera power is turned off.

Shooting in a My Colors Mode







Available Shooting Modes >> p. 189

You can change the look of an image when it is shot.

	My Colors Off	Records normally with this setting.
	Vivid	Emphasizes the contrast and color saturation to record bold colors.
	Neutral	Tones down the contrast and color saturation to record neutral hues.
	Sepia	Records in sepia tones.
	B/W	Records in black and white.
	Custom Color	Use this option to adjust contrast, sharpness and saturation before shooting.

1 Select a My Colors setting.

1. Press the  button.
2. Use the  or  button to select  and the  or  button to change the option.
3. Press the  button.







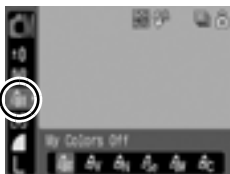

(Setting the Custom Color Mode)

1 Select .

1. Press the  button.
2. Use the  or  button to select  and the  or  button to select .



2 Adjust the setting.

1. Press the  button.
2. Use the  or  button to select [Contrast], [Sharpness] or [Saturation].
3. Use the  or  button to adjust the setting.
 - The adjustment results show in the LCD monitor.
 - If you press the **DISP.** button, you will return to the screen where you can select a My Colors mode.
4. Press the  button.
 - Return to the shooting screen to shoot.



Select an item Adjust

Setting the Display Overlays



Available Shooting Modes >> p. 189

You can display vertical and horizontal grid lines, a 3:2 print area guide, or both on the LCD monitor while shooting to help check the position of your subject.



Off	–
Grid Lines	Displays grid lines to divide the screen into 9 parts. Helps confirm the vertical and horizontal positioning of the subject.
3:2 Guide	Helps confirm the print area for L-size or postcard size in 3:2 aspect ratio*. Areas outside the printable area are grayed out. * Images are still recorded at the standard aspect ratio of 4:3.
Both	Displays both the grid lines and the 3:2 guide simultaneously.

1 Select [Disp. Overlay].

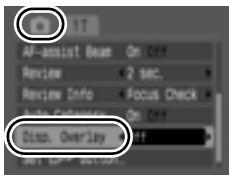

1. Press the  button.
2. In the  menu, use the  or  button to select [Disp. Overlay].

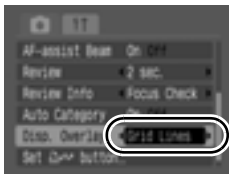

2 Make settings.

1. Use the  or  button to select the option.
2. Press the  button.



- Only grid lines can be configured for the  or  mode.
- The grid lines and 3:2 guide will not be recorded in the image.

Categorizing Images Automatically (Auto Category)



Available Shooting Modes >> p. 189

If you set Auto Category to [On], images are automatically sorted into preset categories as they are recorded.

	People	For images shot in , or mode, or images with faces detected when [AF Frame] is set to [Face Detect].
	Scenery	For images shot in , , or mode.
	Events	For images shot in , , , or mode.

1 Select [Auto Category].

1. Press the button.
2. In the menu, use the or button to select [Auto Category].

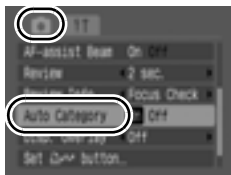

2 Make settings.

1. Use the or button to select [On] or [Off].
2. Press the button.

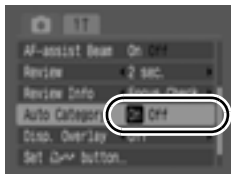









Movies are not automatically categorized, but they can be categorized using the My Category function (p. 109).

Registering Settings to the Button

Available Shooting Modes  p. 189

You can register a function that you often use when shooting with the  button.





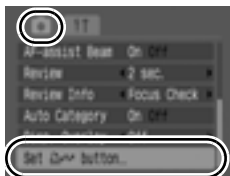

Menu Item	Page	Menu Item	Page
 Not Assigned	–	 Red-Eye Corr.	p. 76
 Face Select and Track	p. 82	 Digital Tele-converter	p. 58
 Exposure Compensation	p. 90	 Disp. Overlay	p. 99
 White Balance	p. 94	 Display Off	p. 51
 Custom White Balance	p. 95		

1 Select [Set button].

1. Press the  button.
2. In the  menu, use the  or  button to select [Set  button].
3. Press the  button.



2 Make settings.

1. Use the  ,  ,  or  button to select the function you wish to register.
2. Press the  button.
 - If  displays to the icon's lower right, you can register the function, but you cannot use it with some shooting modes or settings even if you press the  button.
 - Pressing the **MENU** button completes the setting.















To Cancel the Shortcut Button:

Select  in Step 2.

Using the Button

1 Press the button.

- For ,  and , each time that the  button is pressed, the settings of the registered functions are switched.
- For ,  and , the corresponding setup screen is displayed.
- For , each press of the  button records the white balance data. Since the frame does not appear at this point, ensure that the white paper or cloth is positioned so it appears at the center of the LCD monitor and then press the  button. After using this function once, the white balance setting changes to .
- For , pressing the  button turns off the LCD monitor. The next time a button is pressed, the LCD monitor will turn back on.

Playback/Erasing

Please also see *Viewing Still Images* (p. 18).

Q Viewing Magnified Images



1 Press the zoom lever toward .

-  will display at the upper right and a magnified portion of the image will display.
- Images can be magnified up to a factor of approximately 10x.



Approximate location of the displayed area

2 Use the , , or button to move around the image.

- If you press the **FUNC./SET** button while in magnified display, the camera switches to image advance mode and  will display. You can use the  or  button to advance to the next or previous image at the same level of magnification. The image advance mode is cancelled when you press the **FUNC./SET** button again.
- You can change the magnification level with the zoom lever.

To Cancel the Magnified Display:

Press the zoom lever toward . (You can also cancel it immediately by pressing the **MENU** button.)



Movie frames and index playback images cannot be magnified.

❑ Viewing Images in Sets of Nine (Index Playback) ▶

1 Press the zoom lever toward **❑**.

- Up to nine images can be viewed at once in index playback.
- Use the **↑**, **↓**, **←** or **→** button to change the image selection.



To Return to Single Image Playback:

Press the zoom lever toward **Q**.

Switching between Sets of Nine Images

The jump bar will display if you press the zoom lever toward **❑** while in index playback and you can switch the display between sets of nine images.

- Use the **←** or **→** button to move to the previous or next set of 9 images.
- Hold the **FUNC./SET** button down and press the **←** or **→** button to jump to the first or last set.

To Return to Single Image Playback:

Press the zoom lever toward **Q**.

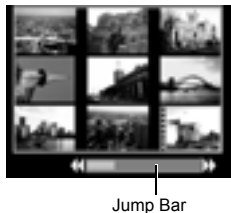

Check the Focus and Facial Expressions of Subjects (Focus Check Display)

Focus Check display allows you to check the focus of images taken. Moreover, as you can change the display size and switch images, you can easily check facial expressions and whether a subject's eyes are closed.

Displaying the Focus Check

- 1** Set the mode switch to  (playback).

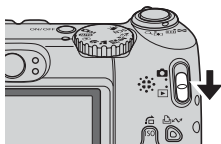

- 2** Press the  button several times until the Focus Check displays.

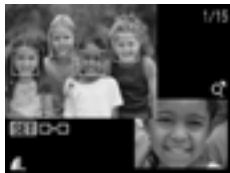

- Frames are displayed on the image as follows.

Frame color	Content
Orange	Displays the range of the image displayed at bottom right.
White	The frame is displayed at a position at which the image is in focus.
Gray	Displays frames in positions where faces were detected during playback.

- The orange frames allow you to change the display size, move the display position, and switch between display frames (p. 106).





Changing the Display Size and Switching Frames

3 Press the zoom lever toward .

- Bottom right of the screen will be displayed prominently and the display size and display position can be changed.



4 Change the setting.

- You can change the display size by pressing the zoom lever.
- You can change the display position by using the , ,  or  button.
- When you press the **FUNC./SET** button, the orange frame returns to its original position. When there are multiple frames displayed, the **FUNC./SET** button changes the position of the orange frame.



To Cancel Changing the Display Position:

Press the **MENU** button.

Switching Frames





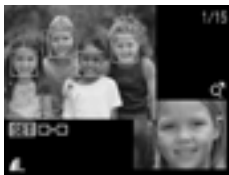

3 Press the button.

- When multiple in-focus frames are displayed, or when multiple faces are detected, the position of the orange colored frame will change each time the **FUNC./SET** button is pressed. After you change the display size, the orange frame will adjust to the size of the face when you switch the position of the frame.



Jumping to Images

When you have many images recorded onto a memory card, it is handy to use the search keys below to jump over images to find the object of your search.

	Jump Shot Date	Jumps to the first image of each shooting date.
	Jump to My Category	Jumps to the first image of each folder sorted by the Auto Category (p. 100) or My Category (p. 109) functions.
	Jump to Folder	Displays the first image in each folder.
	Jump to Movie	Jumps to a movie.
	Jump 10 images	Jumps over 10 images at a time.
	Jump 100 images	Jumps over 100 images at a time.

1 In single image playback mode, press the button.

- The camera will switch to jump search mode.

2 Use the or button to select a search key.

- You can show/hide image information using the **DISP.** button.
- When an image is not categorized, My Category will not display.

Image Information

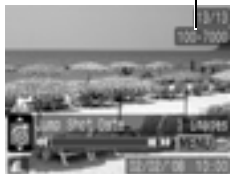

3 Display the Images.

1. Press the **←** or **→** button.
 - Pressing the **MENU** button cancels the setting.
 - Press the **FUNC./SET** button to display the movie control panel (p. 111) when the is selected .

Number of images matching search key

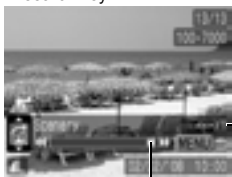

Location of image currently being displayed

To Return to Single Image Playback:

Press the **MENU** button.

Organizing Images by Category (My Category)



You can organize images into prepared categories. Once organized into categories, you can jump to and display the image you want (p. 107).

	People		My Category 1 – 3
	Scenery		To Do
	Events		

1 Select [My Category].

1. Press the button.
2. In the menu, use the or button to select .
3. Press the .

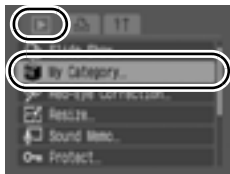

2 Make settings.

1. Use the or button to select an image to classify.
2. Use the or button to select a category.
3. Press the .



- You can cancel the classification by pressing the **FUNC./SET** button again.
- Press the **MENU** button to complete the setting.
- You can also set this in index playback.

Viewing Movies



1 Display a movie.

1. Use the **←** or **→** button to select a movie.
2. Press the **FUNC./SET** button.

- Images with a **SET**  icon are movies.



2 Play the movie.











1. Use the **←** or **→** button to select .
2. Press the **FUNC./SET** button.

- The movie will pause if you press the **FUNC./SET** button during playback. It will resume when you press the button again.
- When playback ends, the movie stops at the last frame displayed. Press the **FUNC./SET** button to display the movie control panel.
- You can switch between showing/hiding the playback progress bar by pressing the **DISP.** button while playing a movie.
- If playback was halted partway through in the prior viewing session, playback will resume from the last frame displayed.

Movie Control Panel



Operating the Movie Control Panel

	Exit	Ends playback and returns to single image playback.
	Print	An icon will display when a printer is connected. See the <i>Direct Print User Guide</i> for details.
	Play	Play.
	Slow Motion	You can use the  button to slow down or the  button to speed up playback.
	First Frame	Displays the first frame.
	Previous Frame	Rewinds if the FUNC./SET button is held down.
	Next Frame	Fast Forwards if the FUNC./SET button is held down.
	Last Frame	Displays the last frame.



Movies cannot be played in the index playback mode.



- Use the television's controls to adjust the volume when playing a movie on a TV set ([p. 141](#)).
- The sound cannot be played in slow motion playback.

Rotating Images in the Display



Images can be rotated clockwise 90° or 270° in the display.



Original



90°





270°

1 Select [Rotate].

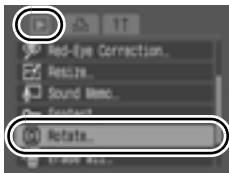
1. Press the  button.
2. In the  menu, use the  or  button to select .
3. Press the  button.



2 Rotate the image.

1. Use the  or  button to select an image to rotate.
2. Press the  button.
 - Cycle through the 90°/270°/original orientations with each press of the **FUNC./SET** button.
 - This also can be set in the index playback mode.







When images are downloaded to a computer, the orientation of images rotated by the camera will depend upon the software used to download the images.



As the orientation of an image is recorded, the image will be shown in its rotated orientation the next time it is displayed.

Playback with Transition Effects

You can select the transition effect displayed when switching between images.



	No transition effect.
	The displayed image darkens and the next image gradually brightens until it is displayed.
	Press the  button to have the previous image display from the left and the  button to have the next image display from the right.

1 Select [Transition].

1. Press the  button.
2. In the  menu, use the  or  button to select .





2 Make settings.

1. Use the  or  button to select a transition effect.
2. Press the  button.



Automated Playback (Slide Shows)

Use this feature to automatically play back all of the images in the memory card. The LCD monitor displays each image for approximately 3 seconds.



	No transition effect.
	The new image gradually brightens as it moves upward from the bottom.
	The previous image moves to the left and the next image display from the right.

1 Select [Slide Show].

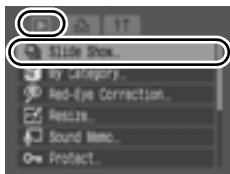
1. Press the  button.
2. In the  menu, use the  or  button to select .
3. Press the  button.



2 Select an effect.

1. Use the  or  button to select an effect and make it active.



3 Play.

1. Press the  button.

- The following functions are available during slide shows.
 - Pausing/resuming the slide show: Press the **FUNC./SET** button.
 - Fast forwarding/rewinding the slide show: Press the **◀** or **▶** button (continue to hold the button to switch between images more rapidly).
 - Stopping the slide show: Press the **MENU** button.



In single image playback mode, you can start a slide show from the current image displayed by holding the **FUNC./SET** button while you press the  button. Please note that if you do this while the last image shot is displayed, the slide show will start from the first image using the same date.

Red-Eye Correction Function

You can correct red eyes in recorded images.



Red eyes may not be automatically detected in some images or the results may not turn out as you intended.

We recommend that you use [New File] to save corrected images.

Examples:



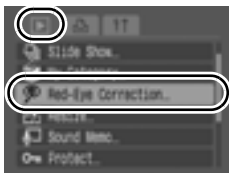

- Faces near the screen edges or faces that appear extremely small, large, dark or bright in relation to the overall image.
- Faces turned to the side or at a diagonal, or faces with a portion hidden.

1 Select [Red-Eye Correction].

1. Press the  button.
2. In the  menu, use the  or  button to select .
3. Press the  button.





2 Select an image.

1. Use the  or  button to select the image you wish to correct red eyes.
2. Press the  button.
 - A frame will automatically display where red-eye is detected.
 - If red-eye is not automatically detected, select [Add Frame] with the  or  button and press **FUNC./SET** button (p. 118).
 - To cancel the correction frame, select [Remove Frame] and press the **FUNC./SET** button (p. 119).



3 Correct the image.

1. Use the  or  button to select [Start].
2. Press the  button.



4 Save the image.

1. Use the ◀ or ▶ button to select [New File] or [Overwrite].
2. Press the  button.



- [New File]: Saved as new file with a new name. The uncorrected image is stored. The new image is stored as the last file.
- [Overwrite]: Saved with the same file name as the uncorrected image. The uncorrected image is erased.
- When [New File] is selected, proceed to the procedure 5.
- If you wish to continue correcting another image, repeat operations from step 2.

5 Display the saved image.

1. Press the  button.
2. Use the ◀ or ▶ button to select [Yes].
3. Press the  button.



- Selecting [No] returns to the Play menu.



- Red-eye correction cannot be performed on movies.
- Overwriting cannot be performed on protected images.



- When there is not enough space left on the memory card, red-eye correction cannot be performed.
- Although you can apply red-eye correction any number of times to an image, the image quality will gradually deteriorate with each application.
- Since the correction frame will not appear automatically on images that have already been corrected once with the Red-Eye Correction function, use the [Add Frame] option to correct them.

Add Correction Frame

1 Select [Add Frame].

1. Use the \uparrow , \downarrow , \leftarrow or \rightarrow button to select [Add Frame].
2. Press the  button.

- A green frame will display.



2 Adjust the position of the correction frame.

1. Use the \uparrow , \downarrow , \leftarrow or \rightarrow button to move the frame.
- Size of the frame can be changed with the zoom lever.



3 Add additional correction frames.

1. Press the  button.

- A correction frame is added and the frame color changes to white.
- If you wish to add additional frames, adjust the position and press the **FUNC./SET** button.
- Up to 35 additional frames can be added.
- To end the adding of correction frames, press the **MENU** button.



To correctly perform red-eye correction, take note of the following (refer to the image in step 2):

- Adjust the correction frame size so that it only surrounds the red-eye portion to be corrected.
- When there are several subjects with red-eye, be sure to add one correction frame per subject.

Removing Correction Frames

1 Select [Remove Frame].

1. Use the \uparrow , \downarrow , \leftarrow or \rightarrow button to select [Remove Frame].
2. Press the  button.



2 Adjust the position of the correction frame.

1. Use the \leftarrow or \rightarrow button to select a frame to remove.
 - The selected frame will appear in green.



3 Delete the frame.

1. Press the  button.
 - The selected frame will disappear.
 - To continue deleting frames, repeat operations from step 2.
 - When you finish deleting frames, press the **MENU** button.

Resizing Images



You can resave images that were recorded at high recording pixel settings at lower settings.



M3	1600 × 1200 pixels
S	640 × 480 pixels
XS	320 × 240 pixels

1 Select [Resize].

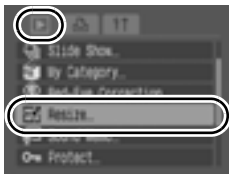
1. Press the  button.
2. In the  menu, use the  or  button to select .
3. Press the  button.







2 Select an image.

1. Use the  or  button to select an image to resize.
 2. Press the  button.
- The **FUNC./SET** button is not selectable for images that cannot be resized.



3 Select a resolution.

1. Use the  or  button to select a resolution.
 2. Press the  button.
- If a resolution cannot be selected due to a lack of free space on the memory card,  will display.





4 Save the image.

1. Use the ◀ or ▶ button to select [OK].
2. Press the  button.

- The resized image will be saved in a new file. The original image will remain.
- If you wish to continue resizing of another image, repeat operations from step 2.



5 Display the saved image.

1. Press the  button.
2. Use the ◀ or ▶ button to select [Yes].
3. Press the  button.

- Selecting [No] returns to the Play menu.



and images shot in  mode cannot be resized.

Attaching Sound Memos to Images



In playback mode, you can attach sound memos (up to 1 min.) to an image. The sound data is saved in the WAVE format.

1 Select [Sound Memo].

1. Press the button.
2. In the menu, use the or button to select .
3. Press the button.

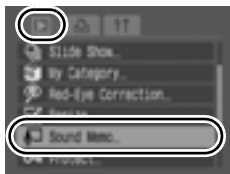

2 Select an image.

1. Use the or button to select an image to which you wish to attach a sound memo.
 2. Press the button.
- The sound memo control panel will display.



3 Record the memo.

1. Use the or button to select .
2. Press the button.

- The elapsed time and the remaining time display.
- Pressing the **FUNC./SET** button pauses the recording. Pressing it again resumes recording.
- Up to 1 minute of recordings can be added to any one image.
- Press the **MENU** button several times to complete the setting.

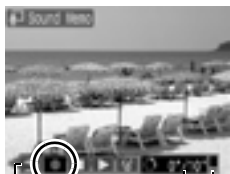





Sound Memo Panel

Elapsed Time/
Remaining Time

Volume
(Adjust it with the or button)

Sound Memo Panel

Use the ← or → button to select an option and press **FUNC./SET** button.

	Exit	Returns to the playback screen.
	Record	Starts recording.
	Pause	Pauses recording or playback.
	Play	Begins playback.
	Erase	Erases sound memos. (Select [Erase] and in the confirmation screen press the FUNC./SET button.)



- You cannot attach sound memos to movies.
- Sound memos for protected images cannot be erased.

Protecting Images



You can protect important images and movies from accidental erasure.

1 Select [Protect].

1. Press the  button.
2. In the  menu, use the  or  button to select .
3. Press the  button.

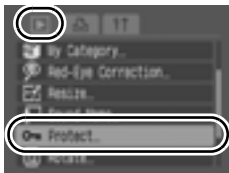

2 Protect an image.

1. Use the  or  button to select an image to protect.
2. Press the  button.

- The protection icon appears on the lower left of image.
- Pressing the **FUNC./SET** button again cancels the setting.
- If you wish to continue protecting of another image, repeat operations.
- You can also protect images in the index playback mode.
- Press the **MENU** button to complete the setting.

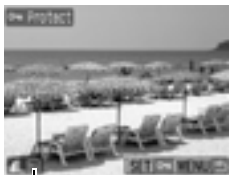

Protection Icon

Erasing All Images



You can erase images from a memory card.



- Note that erased images cannot be recovered. Exercise adequate caution before erasing an image.
- Protected images cannot be erased with this function.

1 Select [Erase all].

1. Press the button.
2. In the menu, use the or button to select .
3. Press the button.

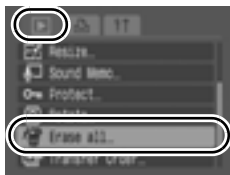

2 Erase the images.

1. Use the or button to select [OK].
 2. Press the button.
- To exit instead of erasing, select [Cancel].



Please format the memory card when you want to erase not only image data but also all the data contained on the memory card (p. 134).

Print Settings/Transfer Settings

Setting the DPOF Print Settings



You can select images on a memory card for printing and specify the number of print copies in advance using the camera. The settings used on the camera comply with the Digital Print Order Format (DPOF) standards. This is extremely convenient for printing on a direct print compatible printer, or for sending the images to a photo developing service that supports DPOF.



- The specified print settings are also applied to the Print List (p. 21).
- The output of some printers or photo developing services may not reflect the specified print settings.
- Print settings cannot be set for movies.
- The  icon may display for a memory card with print settings set by a different DPOF-compliant camera. These settings will be overwritten by those set by your camera.







Setting the Print Style

After setting the print style, select the images for printing. The following settings can be selected.

* Default setting



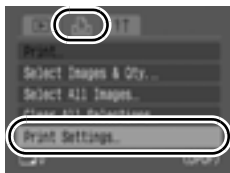

Print Type	<input checked="" type="checkbox"/> Standard*	Prints one image per page.
	<input type="checkbox"/> Index	Prints the selected images together at a reduced size in an index format.
	<input type="checkbox"/> <input checked="" type="checkbox"/> Both	Prints the images in both the standard and index formats.
<input checked="" type="checkbox"/> Date (On/Off*)		Adds the date to the print.
<input checked="" type="checkbox"/> File No. (On/Off*)		Adds the file number to the print.
Clear DPOF data (On*/Off)		Clears all print settings after the images print.

1 Select [Print Settings].



1. Press the  button.
2. Use the  or  button to select the  menu.
3. Use the  or  button to select [Print Settings].
4. Press the  button.

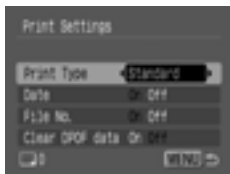

2 Make settings.

1. Use the  or  button to select an option.
2. Use the  or  button to specify the settings.
3. Press the  button.









- The Date and File No. settings change according to the Print Type as follows.
 - [Index]:
[Date] and [File No.] cannot be set to [On] at the same time.
 - [Standard] or [Both]:
[Date] and [File No.] can be set to [On] at the same time, however, the printable information may vary between printers.
- Images dated using  (Date Stamp) (p. 22) are always printed with the date, regardless of the [Date] setting. As a result, some printers may print the date twice on these images if [Date] is also set to [On].
- Dates print in the style specified in [Date/Time] in the  menu (p. 51).

Single Images

When [Print Type] (p. 126) is set to [Standard] or [Both], the number of copies can be set.

1 Select [Select Images & Qty.].







1. Press the  button.
2. Use the  or  button to select the  menu.
3. Use the  or  button to select [Select Images & Qty.].
4. Press the  button.



2 Select the images.

- Selection methods differ for the Print Type settings (p. 126).



Standard () / Both ():

1. Use the  or  button to select the images.
2. Press the  button.
3. Use the  or  button to select the number of print copies (up to 99).
4. Press the  button.

Number of Print Copies



Index ():

1. Use the  or  button to select the images.
2. Select and deselect with the  button.
3. Press the  button.

Index Print Selection

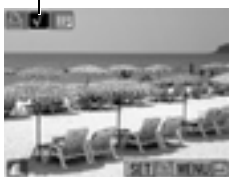







- You can also select images in the index playback mode.

All the Images on a Memory Card



One copy of every image will be set to print.

1 Select [Select All Images].

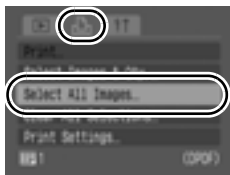

1. Press the  button.
2. Use the  or  button to select the  menu.
3. Use the  or  button to select [Select All Images].
4. Press the  button.



2 Select [OK].

1. Use the  or  button to select [OK].
2. Press the  button.



- Images are printed in order according to the file number.
- A maximum of 998 images can be selected.
- When the camera is connected to a printer, the  button will light blue. At this time, press the  button, confirm that [Print] is selected, and when the **FUNC./SET** button is pressed, printing will begin.
- Selecting [Clear All Selections] in Step 1 cancels all print settings.

Setting the DPOF Transfer Settings

You can use the camera to specify settings for images before downloading to a computer. Refer to the *Software Starter Guide* for instructions on how to transfer images to your computer. The settings used on the camera comply with the DPOF standards.





The  icon may display for a memory card with transfer settings set by a different DPOF-compliant camera. These settings will be overwritten by those set by your camera.

1 Select [Transfer Order].

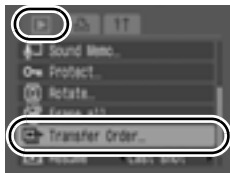
1. Press the  button.
2. In the  menu, use the  or  button to select .
3. Press the  button.



2 Select an order method.

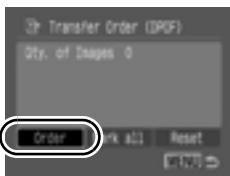

1. Use the  or  button to select an order method.
 - Order : Select single images.
 - Mark all : Select all the images on a memory card.
2. Press the  button.



- Selecting [Reset] cancels all transfer order settings.

Single Images

3 Select an image to transfer.



1. Use the **←** or **→** button to select an image to transfer.
2. Press the  button.
 - Pressing the **FUNC./SET** button again deselects the setting.
 - You can also select images in the index playback mode.
3. Press the  button several times to end the setting.

Transfer Selection



Mark all

3 Execute the transferring images.

1. Use the **←** or **→** button to select [OK].
2. Press the  button.
3. Press the  button.

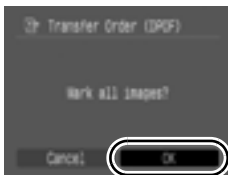

- Images are transferred in order according to the file number.
- A maximum of 998 images can be selected.

Configuring the Camera







Power Saving Function



This camera is equipped with a power saving function, which can automatically turn off the power or LCD monitor.

Auto Power Down	<p>When set to [On], the power will shut off in the following circumstances. Press the ON/OFF button again to restore power.</p> <p>Shooting mode: Approximately 3 minutes after the last control is accessed on the camera</p> <p>Playback mode or when connected to a printer: Approximately 5 minutes after the last control is accessed on the camera.</p>
Display Off	<p>In shooting mode, the LCD monitor automatically turns off after the selected time if no control is accessed, regardless of the [Auto Power Down] setting. Press any button other than the ON/OFF button or change the camera orientation to turn the LCD monitor back on.</p>

1 Select [Power Saving].

1. Press the  button.
2. Use the  or  button to select the  menu.
3. Use the  or  button to select [Power Saving].
4. Press the  button.

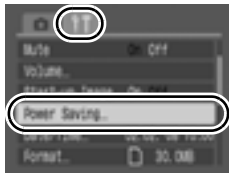

2 Make settings.

1. Use the **↑** or **↓** button to select an option.
2. Use the **←** or **→** button to make settings.
3. Press the  button.

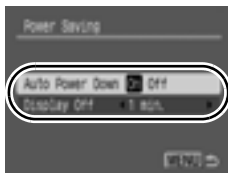

3 Press the button.



The power saving function will not activate during a slide show or while the camera is connected to a computer.

Formatting Memory Cards









You should always format a new memory card or one from which you wish to erase all images and other data.







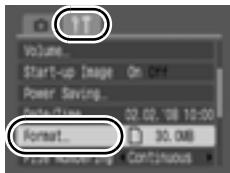

Please note that formatting (initializing) a memory card erases all data, including protected images and other file types.

1 Select [Format].

1. Press the  button.
2. Use the  or  button to select the  menu.
3. Use the  or  button to select [Format].
4. Press the  button.



2 Make settings.

1. Use the  or  button to select [OK].
2. Press the  button.
 - To perform a low level format, use the  button to select [Low Level Format] and the  or  button to add a check mark.
 - You can stop formatting a memory card when [Low Level Format] is selected by pressing the **FUNC./SET** button. You can still use a memory card without problem when formatting is halted, but its data will be erased.

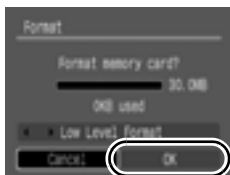

Low Level Format

We recommend you select [Low Level Format] when you think that the recording/reading speed of a memory card has dropped. A low level format may require 2 to 3 minutes with some memory cards.







Resetting the File Number



The images you shoot are automatically assigned file numbers. You can select how the file number is assigned.



Continuous	<p>A number one higher than the last one recorded is assigned to the next image. This is convenient for managing all your images together on a computer because you avoid file name duplication when changing folders or memory cards.*</p> <p>* When a blank memory card is used. If a memory card with recorded data is used, the 7-digit number for the last recorded folder and image is compared with the last one on the memory card, and the larger of the two is utilized as the basis for new images.</p>
Auto Reset	<p>The image and folder number are reset to the starting value (100-0001).* This is convenient for managing images on a folder-by-folder basis.</p> <p>* When a blank memory card is used. If a memory card with recorded data is used, the number following the 7-digit number for the last recorded folder and image on the memory card is utilized as the basis for new images.</p>

1 Select [File Numbering].

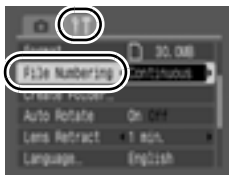
1. Press the  button.
2. Use the  or  button to select the  menu.
3. Use the  or  button to select [File Numbering].



2 Make settings.

1. Use the  or  button to select a file numbering setting.
2. Press the  button.

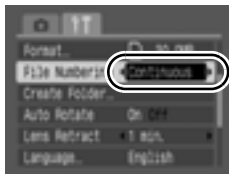

File and Folder Numbers

Recorded images are assigned consecutive file numbers starting with 0001 and ranging up to 9999, while folders are assigned numbers starting with 100 and ranging up to 999. Up to 2000 images can be saved into a single folder.

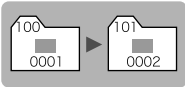
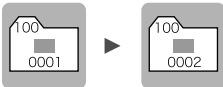
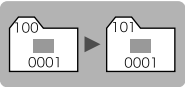
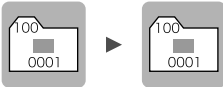
	New Folder Created	Memory Card Exchanged for Another
Continuous	Memory Card 1 	Memory Card 1 Memory Card 2 
Auto Reset	Memory Card 1 	Memory Card 1 Memory Card 2 

- Images may be saved to a new folder when there is insufficient free space even if the total number of images in a folder is less than 2000 because the following types of images are always saved together into the same folder.
 - Images from continuous shooting
 - Self-timer images (custom)
- Images cannot be played back when the folder numbers are duplicated or image numbers are duplicated within folders.
- Please refer to the *Software Starter Guide* for information regarding folder structures or image types.



Creating an Image Destination (Folder)

You can create a new folder at any time and the recorded images will be automatically saved to that folder.

Create New Folder	Creates a new folder the next time you shoot images. To create an additional folder, insert the check mark again.
Auto Create	You can also specify a date and time if you wish to create a new folder using a shooting time after the specified date and time.



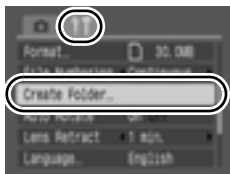

Creating a Folder the Next Time You Shoot

1 Select [Create Folder].

1. Press the  button.
2. Use the  or  button to select the  menu.
3. Use the  or  button to select [Create Folder].
4. Press the  button.







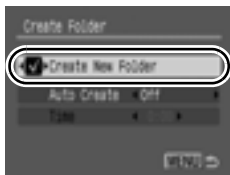

2 Make settings.

1. Use the  or  button to check mark [Create New Folder].
2. Press the  button.
 -  will be displayed on the LCD monitor when shooting. The symbol will disappear from the screen when a new folder is created.









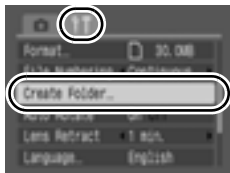

Setting the Day or Time for Automatic Folder Creation

1 Select [Create Folder].

1. Press the  button.
2. Use the  or  button to select the  menu.
3. Use the  or  button to select [Create Folder].
4. Press the  button.



2 Make settings.

1. Use the  or  button to select [Auto Create] and the  or  button to select a creation date.
2. Use the  or  button to select [Time] and the  or  button to select a time.
3. Press the  button.



-  displays when the specified time arrives. The symbol will cease to display after the new folder is created.









Up to 2000 images can be saved into one folder. A new folder will automatically be created when you record more than that number even if you are not creating new folders.

Setting the Auto Rotate Function





Your camera is equipped with an Intelligent Orientation sensor that detects the orientation of an image shot with the camera held vertically and automatically rotates it to the correct orientation when viewing it in the LCD monitor.

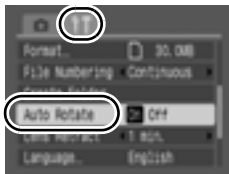

1 Select [Auto Rotate].

1. Press the  button.
2. Use the  or  button to select the  menu.
3. Use the  or  button to select [Auto Rotate].



2 Make settings.

1. Use the  or  button to select [On] or [Off].
2. Press the  button.

- When the Auto Rotate function is set to [On] and the LCD monitor is set to the detailed display mode in the shooting mode,  (normal),  (right end is down) or  (left end is down) will appear in the display.

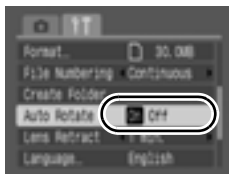

- This function may not operate correctly when the camera is pointed straight up or down. Check that the arrow  is pointing in the right direction and if it is not, then set the Auto Rotate function to [Off].
- Even if the Auto Rotate function is set to [On], the orientation of images downloaded to a computer will depend upon the software used to download the images.







When the camera is held vertically to shoot, the Intelligent Orientation sensor judges the upper end to be “up” and the lower end to be “down”. It then regulates the optimal white balance, exposure and focus for vertical photography. This function operates regardless of the on/off status of the Auto Rotate function.

Resetting Settings to Their Default Values



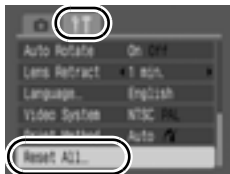

1 Select [Reset All].

1. Press the  button.
2. Use the  or  button to select the  menu.
3. Use the  or  button to select [Reset All].
4. Press the  button.



2 Make settings.

1. Use the  or  button to select [OK].
2. Press the  button.

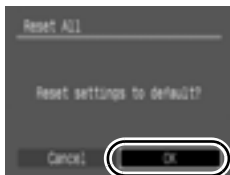

- Settings cannot be reset when the camera is connected to a computer or to a printer.
- The following cannot be reset.
 - The shooting mode.
 - The [Date/Time], [Language] and [Video System] options in the  menu (pp. 51, 52)
 - White balance data recorded with the custom white balance function (p. 95)

Connecting to a TV

Shooting/Playback Using a TV



You can use the supplied AV cable to shoot or playback images using a TV.

1 Turn off the camera and the TV.

2 Connect the AV cable to the camera's A/V OUT terminal.

- Open the terminal cover and plug the AV cable in all the way.

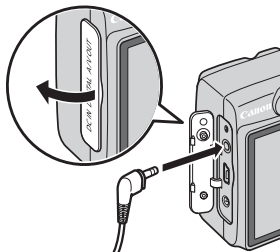

3 Plug the other ends of the AV cable to the VIDEO IN and AUDIO IN jacks on the TV.

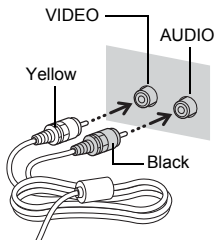

4 Turn on the TV and switch it to video mode.

5 Turn on the camera.



- The video output signal can be switched (NTSC or PAL) to accommodate different regional standards ([p. 52](#)). The default setting varies between regions.
 - NTSC: Japan, U.S.A., Canada, Taiwan and others
 - PAL: Europe, Asia (excluding Taiwan), Oceania and others
- If the video system is set incorrectly, the camera output may not display properly.

Troubleshooting

- Camera (p. 143)
- When the power is turned on (p. 144)
- LCD monitor (p. 144)
- Shooting (p. 146)
- Shooting movies (p. 150)
- Playback (p. 151)
- Battery (p. 152)
- TV monitor output (p. 152)
- Printing with a direct print compatible printer (p. 153)

Camera

Camera will not operate.

Power is not turned on.	● Press the ON/OFF button (p. 42).
Memory card slot/battery cover is open.	● Confirm that the Memory card slot/ battery cover is securely closed (p. 11).
Batteries are loaded in the wrong direction.	● Reload the batteries in the correct direction (p. 10).
Batteries are not the right type.	● Use only unused AA-size alkaline batteries or Canon AA-size NiMH batteries (p. 10).
Battery charge is low and the camera will not operate. ("Change the batteries" message displays).	<ul style="list-style-type: none"> ● Replace the camera batteries with two unused or fully charged batteries (p. 10). ● Use the AC Adapter Kit ACK800 (sold separately) (pp. 36, 170).
Poor contact between camera and battery terminals.	<ul style="list-style-type: none"> ● Poor contact between camera and battery terminals. ● Reload the batteries several times.

Sounds come from the camera interior.

The camera's horizontal/vertical orientation was changed.

- The camera's orientation mechanism is operating. There is no malfunction.

When the power is turned on

"Card locked!" message appears.

The SD memory card's or SDHC memory card's write protect tab is set to "Write protect".

- When recording to, erasing from or formatting the memory card, slide the write protect tab upward (p. 165).

The Date/Time menu appears.

The lithium date battery charge is depleted.

- Replace the lithium date battery (p. 173).

The battery holder was removed.

- The date and time settings need to be reset since they were lost (p. 13).

LCD monitor

Nothing displays.

The LCD monitor is set not to display.

- Press the **DISP.** button to turn on the LCD monitor (p. 53).

[Power Saving] is set to [Display Off].

- Press any button other than the ON/OFF button or change the camera orientation to turn the LCD monitor back on (p. 132).

The display darkens.

The image in the LCD monitor will darken in strong sunlight or bright light.

- This is a normal occurrence in devices containing CCDs and does not constitute a malfunction. This image will not be recorded when shooting still photos, but it will be recorded when shooting movies.

Display flickers.

Display flickers when shot under fluorescent lighting.

- This is not a camera malfunction (flickering recorded in movies, but not in still images).

A bar of light (purplish red) appears on the LCD monitor.

Sometimes appears when shooting a bright subject, such as the sun or other light source.

- This is a normal occurrence in devices containing CCDs and does not constitute a malfunction. This bar of light will not be recorded when shooting still photos, but it will be recorded when shooting movies.

 appears.

A slow shutter speed has likely been selected because of insufficient lighting.

- Raise the ISO speed (p. 65).
- Set the flash to any setting other than  (flash off) (p. 59).
- Set the self-timer and secure the camera to something, such as a tripod (p. 61).

 appears.

This displays when using a memory card that has print settings, transfer settings or slide show image settings set by other DPOF-compliant cameras.

- These settings will be overwritten by those set by your camera (pp. 126, 130).

Noise displays./Subject's movements are irregular.

Camera automatically lightened the image displayed on the LCD monitor to make it easier to see when shooting in a dark area (p. 54).

- There is no effect on the recorded image.

Shooting

Camera will not record.

Camera is in playback mode or connecting to a computer/printer mode.	<ul style="list-style-type: none"> ● Switch to Shooting mode (p. 15).
Flash is charging.	<ul style="list-style-type: none"> ● When the flash is charged, the indicator will light orange. Shooting is now possible (p. 43).
Memory card is full.	<ul style="list-style-type: none"> ● Insert a new memory card (p. 10). ● If required, download the images to a computer and erase them from the memory card to make space.
Memory card is not formatted correctly.	<ul style="list-style-type: none"> ● Format the memory card (p. 134). ● If reformatting does not work, the memory card logic circuits may be damaged. Consult the nearest Canon Customer Support Help Desk.
SD memory card or SDHC memory card is write protected.	<ul style="list-style-type: none"> ● Slide the write protect tab upward (p. 165).

Image Seen in Viewfinder vs. Recorded Image.

Usually the recorded image contains more of the scene than is seen in the viewfinder.	<ul style="list-style-type: none"> ● Confirm the actual image size with the LCD monitor. Use the LCD monitor when taking close-up shots (p. 53).
---	---

Image is blurred or out of focus.

The camera moves when the shutter button is pressed.	<ul style="list-style-type: none"> ● Confirm the procedures in “ appears” (p. 145).
--	---

AF-assist Beam is set to [Off].	<ul style="list-style-type: none"> ● In dark places where it is difficult for the camera to focus, the AF-assist Beam will emit to assist focusing. As the AF-assist Beam will not function when turned off, set it [On] to activate it (p. 49). Take care not to obstruct the AF-assist Beam with your hand when used.
Subject is out of focal range.	<ul style="list-style-type: none"> ● Shoot with the subject at the correct focusing distance (p. 176). ● The camera may be set to an unintended function (such as macro). Cancel the setting.
The subject is hard to focus on.	<ul style="list-style-type: none"> ● Use the focus lock or AF lock to shoot (p. 86).

Subject in recorded image is too dark.

Insufficient light for shooting.	<ul style="list-style-type: none"> ● Set the built-in flash to  (Flash on) (p. 59).
The subject is underexposed because the surroundings are too bright.	<ul style="list-style-type: none"> ● Set the exposure compensation to a positive (+) setting (p. 90). ● Use the AE lock or spot metering function (p. 91).
Subject is too far away for flash to reach.	<ul style="list-style-type: none"> ● Shoot within correct flash range of the subject when using the built-in flash (p. 177). ● Raise the ISO speed and then shoot (p. 65).

Subject in recorded image is too bright, or image flashes white.

Subject is too close, making the flash too strong.	<ul style="list-style-type: none"> ● Shoot within correct flash range of the subject when using the built-in flash (p. 177).
The subject is overexposed because the surroundings are too dark.	<ul style="list-style-type: none"> ● Set the exposure compensation to a negative (-) setting (p. 90). ● Use the AE lock or spot metering function (p. 91).

Too much light is shining directly into the camera, or is being reflected off the subject.





- Change the shooting angle.

Flash is set to  (Flash on).

- Set the flash to  (Flash off) (p. 59).

Image contains noise.

ISO speed is too high.

- Higher ISO speeds and  (High ISO Auto) setting may increase image noise. For higher image quality, use as low an ISO speed as possible (p. 65).
- In , ,  and  mode in the **SCN** mode, the ISO speed increases and noise can appear.

White dots appear on the image.

Light from the flash has reflected off dust particles or insects in the air. This is particularly noticeable when you increase the aperture value using the wide angle.

- This is a phenomenon that occurs with digital cameras and does not constitute a malfunction.

Eyes appear red.

Light is reflected back from the eyes when the flash is used in dark areas.

- Shoot with [Red-Eye Lamp] in the [Flash Settings] menu set to [On] (p. 76). For this mode to be effective, the subject must be looking right at the red-eye reduction lamp. Try asking them to look directly at the lamp. Even better results can be obtained by increasing the lighting in indoor settings or approaching closer to the subject. The shutter will not activate for approximately 1 second after the red-eye reduction lamp fires in order to improve the effect.
- If you set the [Red Eye Corr.] in the [Flash Settings] to [On], the camera will automatically correct red eyes while shooting and record the image to the card (p. 76).
- You can correct red eyes in recorded images using the [Red-Eye Correction] (p. 115).

Continuous shooting slows down.

The memory card's performance has dropped.

- To enhance the continuous shooting performance, you are recommended to low level format the memory card in the camera after you save all its images to your computer (p. 134).

Recording images to memory card takes a long time.

Memory card was formatted in another device.

- Use a memory card formatted in your camera (p. 134).

Lens will not retract.

Memory card slot/battery cover was opened with power on.

- After closing the memory card slot/battery cover, turn the power on then back off.

Shooting movies

The recording time may not display properly or shooting may stop unexpectedly.

The following types of memory cards are used.

- Slow recording cards.
- Cards formatted on a different camera or a computer.
- Cards which have had images recorded and erased repeatedly.

- Although the recording time may not display properly during shooting, the movie will be recorded correctly on the memory card. Recording time will display properly if you format the memory card in this camera (excluding slow recording memory cards) (p. 134).

“!” displayed on the LCD monitor in red and shooting automatically stopped.

There is insufficient free space in the camera's built-in memory.

- Try the following procedures.
 - Format the card with a low level format before filming (p. 134).
 - Lower the recording pixels or frame rate (p. 74).
 - Use a high-speed memory card (SDC-512MSH, etc.).

Zoom does not operate.

Zoom lever was pressed while shooting in movie mode.

- Operate the zoom before shooting in movie mode (p. 55). Note the digital zoom is available while shooting (only in Standard movie mode).

Playback

Cannot play back.

You attempted to play back images shot with another camera or images edited with a computer.

- Computer images that cannot be played back may play back if they are added to the camera using the supplied software program ZoomBrowser EX or ImageBrowser.

File name was changed with a computer or file location was changed.

- Set the file name or location on the file format/structure of the camera. (Refer to the *Software Starter Guide* for details).

Images cannot be edited.

Some images shot with another camera cannot be edited.

Movies do not play back correctly.

Movies recorded with high recording pixels may momentarily stop playing if played on slow reading memory cards.

You may experience frame dropping and audio breakup when playing back a movie on a computer with insufficient system resources.

Reading images from memory card is slow.

Memory card was formatted in another device.

- Use a memory card formatted in your camera ([p. 134](#)).

Battery

Batteries consumed quickly.

Battery is not being used to its full capacity.

- See *Battery* (p. 164).

Batteries are not the right type.

- Use only unused AA-size alkaline batteries or Canon AA-size NiMH batteries (p. 164).

Battery capacity drops due to low ambient temperatures.

- If shooting in a cold location, warm the batteries such as by placing them in your pocket before using them.

Battery terminals are dirty.

- Wipe the terminals well with a dry cloth before use.
- Reload the batteries several times.

If using Canon AA-size NiMH batteries

As the batteries have not been used for over a year, their recharging capacity has decreased.

- Their charging performance should return to normal after fully recharging and depleting them over several times.

Battery life has been exceeded.

- Replace both batteries with new ones.

TV monitor output

Image is distorted or not showing on TV monitor.

Incorrect video system setting.

- Set the video system to the appropriate setting, NTSC or PAL, for your TV (p. 52).

Printing with a direct print compatible printer

Cannot print

The camera and printer are not properly connected.	<ul style="list-style-type: none">● Securely connect the camera and printer with the specified cable.
The printer power is not turned on.	<ul style="list-style-type: none">● Turn on the printer power.
The print connection method is not correct.	<ul style="list-style-type: none">● Select [Print Method] and select [Auto] (p. 52).

List of Messages

The following messages may appear on the LCD monitor during shooting or playback. Please refer to the *Direct Print User Guide* for the messages that display during a printer connection.

Busy...

Image is being recorded onto the memory card, red eye correction is being processed.

Resetting all the camera and menu settings to default.

No memory card

You turned on the camera without a memory card installed, or with a memory card installed in the wrong orientation (p. 10).

Card locked!

The SD memory card or SDHC memory card is write protected (p. 165).

Cannot record!

You attempted to shoot an image without a memory card installed, with a memory card installed in the wrong orientation, or attempted to attach a sound memo to a movie.

Memory card error

The memory card may be malfunctioning. By formatting the malfunctioning memory card with the camera, you may be able to continue using it (p. 134). However, if this error message appears even when using the supplied memory card, contact your Canon Customer Support Help Desk as there may be a problem with the camera.

Memory card full

Memory card is full of images and no more can be recorded or saved. In addition, no more image settings, or sounds or sound memos can be recorded.

Naming error!

The file name could not be created because there is an image with the same name as the folder that the camera is attempting to create, or the highest possible file number has already been reached. In the Set up menu, set [File Numbering] to [Auto Reset]; alternatively, save all the images you wish to retain onto a computer, then reformat the memory card. Please note that formatting will erase all the existing images and other data.

Change the batteries

Battery charge is insufficient to operate the camera. Replace both batteries immediately with unused AA-size alkaline batteries or fully charged Canon AA-size NiMH batteries.

Also refer to *Battery* (p. 164).

No image.

No images recorded on memory card.

Image too large.

You attempted to play back an image larger than 5616 × 3744 pixels or with a large data size.

Incompatible JPEG

You attempted to play back an incompatible JPEG image (edited with a computer, etc.).

RAW

You attempted to play back a different type of RAW image.

Unidentified Image

You attempted to play back an image with corrupted data, an image with a recording type specific to another manufacturer's camera, or an image that has been downloaded to a computer and altered.

Cannot magnify!

You attempted to magnify an image recorded in a different camera or data type, an image edited with a computer, or a movie.

Cannot rotate

You attempted to rotate the image shot with a different camera or data type, or an image edited with a computer.

Incompatible WAVE

A sound memo cannot be added to this image since the data type of the existing sound memo is incorrect. In addition, sound cannot be played back.

Cannot modify image

You attempted to resize or perform red eye correction on a movie or an image recorded with another camera. Or you attempted to resize an image already resized to **X8** or an image shot in **W**.

Cannot assign to category

You attempted to categorize an image recorded in a different camera.

Cannot Modify

Cannot apply red-eye correction as no red-eye is detected.

Cannot transfer!

When transferring images to your computer using the Direct Transfer menu, you attempted to select a RAW image, an image with corrupted data, an image taken with a different camera or data type. You may have also attempted to select a movie when [Wallpaper] was selected in the Direct Transfer menu.

Protected!

You attempted to erase or edit a protected image, movie or sound memo.

Too many marks

Too many images have been marked with print settings or transfer settings. Cannot process any more.

Cannot complete!

Could not save a part of the print or transfer settings.

Unselectable image

You attempted to set the print settings for a non-JPEG image.

Communication error

The computer was unable to download the image due to the large amount of images (approx. 1000) stored on the memory card. Use a USB card reader or a PCMCIA card adapter to download the images.

Lens error, restart camera

An error was detected while the lens was in motion, and the power has been automatically turned off. This error can occur if you hold the lens while it is in motion or you operate it in a location with excessive dust or sand in the air. Try turning the power back on, and resume shooting or playback. If this message continues to display, contact your Canon Customer Support Help Desk as there may be a problem with the lens.

Exx

(xx: number) Camera detected an error. Turn the power off and then back on, then shoot or play back. A problem exists if the error code reappears. Note the number and contact your Canon Customer Support Help Desk. If an error code displays directly after taking a picture, the shot may not have been recorded. Check image in playback mode.

Appendix

Safety Precautions

- Before using the camera, please ensure that you read the safety precautions described below and in the “Safety Precautions” section. Always ensure that the camera is operated correctly.
- The safety precautions noted on the following pages are intended to instruct you in the safe and correct operation of the camera and its accessories to prevent injuries or damage to yourself, other persons and equipment.
- Equipment refers to the camera, battery, battery charger (sold separately) and compact power adapter (sold separately).

Warnings

Equipment

- **Do not point the camera at bright light sources (the sun in bright clear skies, etc.).**
 - Doing so could damage the camera's CCD.
 - Doing so can damage your eyesight.
 - **Store this equipment out of the reach of children and infants.**
 - Wrist strap: Placement of the strap around the child's neck could result in asphyxiation.
 - Memory card: It may be swallowed accidentally. If this occurs, contact a doctor immediately.
-

-
- **Do not attempt to disassemble or alter any part of the equipment that is not expressly described in this guide.**
 - **To avoid the risk of high-voltage electrical shock, do not touch the flash portion of the camera if it has been damaged.**
 - **Stop operating the equipment immediately if it emits smoke or noxious fumes.**
 - **Do not allow the equipment to come into contact with, or become immersed in, water or other liquids. If the exterior comes into contact with liquids or salt air, wipe it dry with a soft, absorbent cloth.**

Continued use of the equipment may result in fire or electrical shock. Immediately turn the camera power off and remove the camera batteries or unplug the battery charger or compact power adapter from the power outlet. Please consult your camera distributor or the closest Canon Customer Support Help Desk.

-
- **Do not use substances containing alcohol, benzene, thinners or other flammable substances to clean or maintain the equipment.**
 - **Do not cut, damage, alter or place heavy items on the power cord.**
 - **Use only recommended power accessories.**
 - **Remove the power cord on a regular periodic basis and wipe away the dust and dirt that collects on the plug, the exterior of the power outlet and the surrounding area.**
 - **Do not handle the power cord if your hands are wet.**

Continued use of the equipment may result in fire or electrical shock.

Battery

- Do not place the batteries near a heat source or expose it to direct flame or heat.
- The batteries should not be immersed in water or sea water.
- Do not attempt to disassemble, alter or apply heat to the batteries.
- Avoid dropping or subjecting the batteries to severe impacts that could damage the casing.
- Use only recommended batteries and accessories.

Failure to follow these precautions may cause explosions or leaks, resulting in fire, injury and damage to the surroundings. In the event that a battery leaks and the eyes, mouth, skin or clothing contact these substances, immediately flush with water and seek medical assistance.

- **Never use damaged batteries or batteries whose outer seal is completely or partially missing or peeled off, as there is risk that such batteries may leak, overheat, or burst. Always check the seals on store-bought batteries before loading them, as some batteries may come with defective seals. Do not use batteries with defective seals.**

Never use batteries that look like this.



Batteries with all or part of the seal (electrical insulation sheath) peeled off.



The positive electrode (plus terminal) is flat.



The negative terminal is correctly formed (protruding from the metal base), but the seal does not extend up over the edge of the metal base.

-
- **Disconnect the battery charger and compact power adapter from both the camera and the power outlet after recharging or when not in use to avoid fire and other hazards.**
 - **Do not place anything, such as tablecloths, carpets, bedding or cushions, on top of the battery charger while it is charging.**

Leaving the units plugged in for a long period of time may cause them to overheat and distort, resulting in fire.

-
- **When recharging the Canon AA-size NiMH batteries, use only a specified battery charger.**
 - **The compact power adapter is designed for exclusive use with this equipment. Do not use it with other products.**

There is a risk of overheating and distortion which could result in fire or electrical shock.

-
- **Before you discard a battery, cover the terminals with tape or other insulators to prevent direct contact with other objects.**

Contact with the metallic components of other materials in waste containers may lead to fire or explosions.

Others

- **Do not trigger the flash in close proximity to human or animal eyes. Exposure to the intense light produced by the flash may damage eyesight.**

In particular, remain at least one meter (39 inches) away from infants when using the flash.

-
- **Keep objects that are sensitive to magnetic fields (such as credit cards) away from the speaker of the camera.**

Such items may lose data or stop working.

 **Cautions****Equipment**

- **Be careful not to bang the camera or subject it to strong impacts or shocks that could lead to injury or damage the equipment when wearing or holding it by the strap.**

- **Be careful not to bump or strongly push the end of the lens.**

The above-mentioned could lead to injury or damage the equipment.

- **Be careful not to allow dust or sand into the camera when using it at a beach or place with strong winds.**

Such conditions could lead to damage.

- **Do not store the equipment in humid or dusty areas.**

- **During shooting, do not allow metal objects (such as pins or keys) or dirt to contact the charger terminals or plug.**

Such conditions could lead to fire, electrical shock or other damage.

- **Avoid using, placing or storing the equipment in places subject to strong sunlight or high temperatures, such as the dashboard or trunk (boot) of a car.**

- **Do not use the equipment in a manner that exceeds the rated capacity of the electrical outlet or wiring accessories. Also, do not use the equipment if the cable or plug is damaged, or if the plug is not fully inserted into the power outlet.**

- **Do not use in locations with poor ventilation.**

The above-mentioned can cause leakage, overheating or explosion, resulting in fire, burns or other injuries. High temperatures may also cause deformation of the casing.

- **When not using the camera for extended periods of time, remove the batteries from the camera or battery charger and store the equipment in a safe place.**

If the batteries are left inside the camera, damage caused by leakage may occur.

Flash

- **Do not operate the flash with dirt, dust or other items stuck to the surface of the flash.**
- **Be careful not to cover the flash with your fingers or clothing when shooting.**

The flash may be damaged and emit smoke or noise. The resulting heat build-up could damage the flash.

- **Do not touch the surface of the flash after taking several pictures in rapid succession.**

Doing so could result in burns.

Preventing Malfunctions

Camera

Avoid Strong Magnetic Fields

- **Never place the camera in close proximity to electric motors or other equipment generating strong electromagnetic fields.**

Exposure to strong magnetic fields may cause malfunctions or corrupt image data.

Avoid Condensation Related Problems

- **When moving the equipment rapidly from cold to hot temperatures, you can avoid condensation by placing the equipment in an airtight, resealable plastic bag and letting it adjust to temperature changes slowly before removing it from the bag.**

If condensation forms on the camera, remove the memory card and batteries, and set the camera aside in room temperature to allow the condensation to naturally evaporate before using the camera again.

Battery

- **This camera uses AA-size alkaline batteries or Canon AA-size NiMH batteries (sold separately).**

While it is possible to use AA-size nickel-cadmium batteries, performance is unreliable and their use is not recommended.

- **Since the performance of alkaline batteries may differ according to brand, the operating time of the batteries you purchase may not be as long as the batteries that came with the camera.**

- **When using the camera under low temperature conditions or over long periods, you are recommend to use of Canon AA-size NiMH batteries (sold separately).**

Camera operating time may shorten at low temperatures when alkaline batteries are used. Also due to their specifications, alkaline batteries may expire faster than NiMH batteries.

- **Never mix unused and partially used batteries.**

The partially used batteries may leak.

- **Do not install the batteries with their terminals (⊕ and ⊖) reversed.**

- **Do not mix batteries of different types or from different manufacturers.**

- **Before installing the batteries, wipe the battery terminals well with a dry cloth.**

If the battery terminals are soiled with oil from one's skin or other dirt, the number of recordable images may be considerably diminished, or the amount of time the camera can be used may be reduced.

- **At low temperatures, battery performance may be reduced and the low battery icon (🔋) may appear earlier than usual.**

Under these conditions, restore the battery performance by warming it in a pocket immediately before use.

- **Do not put the batteries into a pocket together with metallic items such as a key ring.**

The batteries may be short circuited.

- **When not using the camera for long periods, remove the batteries from the camera and store them separately.**

If the batteries are left inside the camera, the camera may become damaged from battery leakage.

Memory Card

- **SD Memory Card or SDHC Memory Card Write Protect Tab**

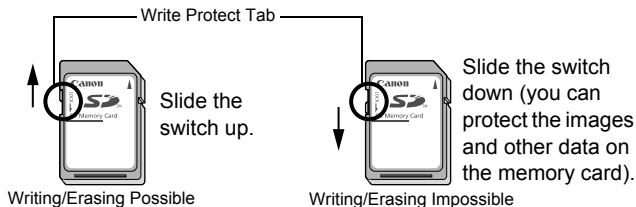

-
- **Memory cards are high-precision electronic devices. Do not bend them, apply force to them, or subject them to shocks or vibration.**
-
- **Do not attempt to disassemble or alter the memory card.**
-
- **Do not allow dirt, water or foreign objects to contact the terminals on the back of the memory card. Do not touch the terminals with your hands or metal objects.**
-
- **Do not peel away the original label on the memory card or cover it with another label or sticker.**
-
- **When writing on the memory card, do not use a pencil or ballpoint pen. Only use a soft point pen (e.g. felt-tip pen).**
-
- **Do not use or store memory cards in the following locations.**
 - Locations subject to dust or sand
 - Locations subject to high humidity and high temperatures
-
- **Since some or all of the data recorded on the memory card may be corrupted or erased by electrical noise, static electricity, camera or memory card malfunction, making a backup copy of important data is recommended.**
-
- **Please note that formatting (initializing) an memory card erases all data, including protected images.**
-
- **You are recommended to use memory cards that have been formatted in your camera.**
 - The memory card supplied with the camera may be used without further formatting.
 - When the camera is malfunctioning, a corrupted memory card might be the cause. Reformatting the memory card may solve the problem.
 - When a non-Canon brand memory card is malfunctioning, reformatting it may solve the problem.
 - Memory cards formatted in other cameras, computers, or peripheral devices may not operate correctly in this camera. When that happens, reformat the memory card with this camera.
-
- **If formatting in the camera does not work properly, turn the camera off and re-insert the memory card. Then turn the camera back on and format again.**
-

- Be careful when transferring or disposing of a memory card. Formatting or erasing the data on a memory card merely changes the file management information on the memory card and does not ensure that its contents are completely deleted. When disposing of a memory card, take precautions, such as physically destroying the memory card, to prevent personal information leaks.

Using the Power Kits (Sold Separately)

Using Rechargeable Batteries (Battery and Charger Kit CBK4-300)

This kit includes a battery charger and four rechargeable AA-size NiMH (nickel metal hydride) batteries. Charge batteries as shown below.

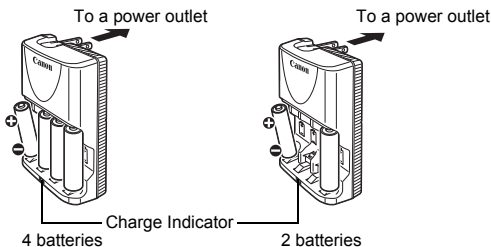

- After inserting the batteries, plug the charger (CB-5AH) into an outlet, or attach the power cord to the charger (CB-5AHE, not shown) and plug the other end into an outlet.
- Do not insert and charge additional batteries once charging has begun.
- The charge indicator blinks while charging, then remains lit when charging is finished.



- The CB-5AH/CB-5AHE battery charger can only be used to charge Canon AA-size NiMH batteries NB-3AH.
- Do not mix batteries with different purchase dates or different charge states. When recharging batteries, always recharge both of them at the same time.
- Do not attempt to recharge fully charged batteries, as doing so may reduce or impair battery performance. Also, do not charge batteries for more than 24 consecutive hours.
- Do not recharge batteries in enclosed areas that tend to retain heat.
- Do not recharge the batteries until the LCD monitor displays the “Change the batteries” message. Repeatedly recharging batteries before they become depleted may cause batteries to lose capacity.
- Wipe the battery terminals well with a dry cloth in the following situations, as the terminals may be soiled with oil from one’s skin or other dirt:
 - If the battery usage time has considerably diminished
 - If the number of recordable images has considerably diminished
 - When charging the batteries (insert and remove the batteries two or three times before charging)
 - When charging completes in a space of a few minutes (the battery charger indicator remains lit)
- You may not be able to fully charge the batteries due to their specifications right after purchase or after long periods of nonuse. If this happens, after fully charging them, use the batteries until their charge is depleted. After doing this several times, battery performance will be restored.



- If you store batteries for a long period of time (about 1 year), it is recommended that you deplete the batteries in the camera and to then store them at room temperature (0 to 30°C/32 to 90°F) in low humidity. Storing them in a fully charged condition can shorten their lifespan or degrade their performance. Again, if you do not use batteries for more than 1 year, fully charge them once a year and deplete them in the camera before storing them.
- If the battery usage time has become considerably low despite wiping the terminals and charging them until the battery charger indicator remains lit, this may indicate that the batteries have reached the end of their lifespan. Replace them with new batteries. If you are purchasing new batteries, look for Canon AA-size NiMH batteries.
- Leaving batteries in the camera or charger may result in damage from battery leakage. When not in use, remove the batteries from the camera or charger and store them in a cool, dry location.



- It takes approximately 4 hours 40 minutes for the charger to fully recharge the batteries after they have been depleted. When two batteries are placed on each side of the charger, recharging will take approximately two hours (as determined by testing at Canon facilities). Charge batteries in an environment where the temperature is in the range of 0 to 35°C (32 to 95°F).
- The charging time varies according to the ambient temperature and to the battery charge state.
- The battery charger may emit noise while charging. This is not a malfunction.

Using the AC Adapter Kit ACK800

It is best to power the camera with AC Adapter Kit ACK800 (sold separately) when you are using it for long periods of time or connecting it to a computer.



Turn the camera power off before connecting or disconnecting the AC adapter.

- 1 Connect the power cord to the compact power adapter first and then plug the other end into the power outlet.**

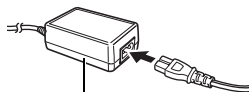

Compact Power Adapter
CA-PS800

- 2 Open the terminal cover and attach the cord to the DC IN terminal.**

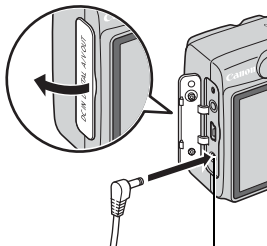

DC IN terminal

Using an Externally Mounted Flash (Sold Separately)

High-Power Flash HF-DC1

This flash is used to supplement the camera's built-in flash when the subject is too far away for proper illumination. Use the following procedures to affix the camera and High-Power Flash to the supporting bracket.

Please read the instructions accompanying the flash along with this explanation.

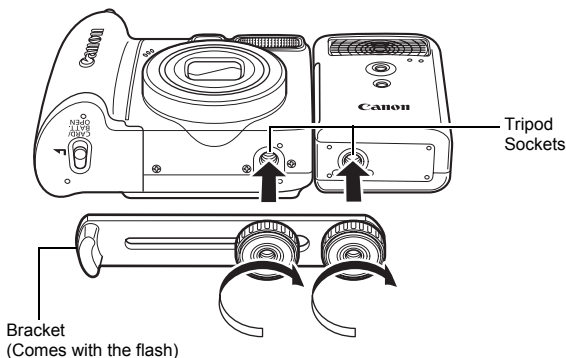

- The flash charge time will lengthen as the battery charge gets weaker. Always set the power/mode switch to off when you finish using the flash.
- Be careful not to touch the flash window or sensor windows with your fingers while the flash is in use.
- The flash may fire if another flash is being used in close proximity.
- The High-Power Flash may not fire outdoors in daylight or when there are no reflective items.

- For continuous shooting, although the flash fires for the first shot, it does not fire for subsequent shots.
- Fasten the attachment screws securely so that they do not loosen. Failure to do so may lead to the dropping of the camera and flash resulting in damage to both.



- Before attaching the bracket to the flash, check that the lithium battery (CR123A or DL123) is installed.
- To illuminate the subjects properly, install the flash so that it is up against the side of the camera and parallel with the camera's front panel.
- A tripod can be used even when the flash is attached.

Batteries

- Charge becomes Severely Limited

If the battery usage time has considerably diminished, wipe the battery terminals well with a dry cloth. The terminals may be dirty from fingerprints.

- Usage in Cold Temperatures

Get a spare generic lithium battery (CR123A or DL123). You are recommended to place the spare battery in your pocket to warm it up before switching it for the battery in the flash.

- Non-Use over Extended Periods

Leaving batteries in the High-Power Flash could allow the battery fluid to leak, damaging the product. Remove the batteries from the High-Power Flash and store them in a cool, dry place.

Replacing the Date Battery

If the Date/Time in the Set up menu appears when the camera power is turned on, the date battery charge is low and the date and time settings have been lost. Please purchase a lithium coin battery (CR1220) and replace it as follows.

The date battery is preinstalled at the factory and may therefore expire earlier than its rated lifespan after the camera has been purchased.



Be particularly careful to keep the date batteries out of the reach of children. Seek medical assistance immediately if a child swallows a battery since corrosive battery fluids could damage the stomach or intestinal wall.

- 1 Confirm that the camera is turned off.**
- 2 Slide the memory card slot / battery cover lock and open the cover.**
- 3 Hook your nail onto the date battery holder and lightly pull it up.**
- 4 Pull out the battery holder in the direction indicated by the arrow.**

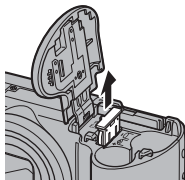
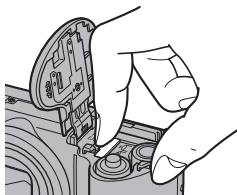

- 5 Remove the battery by pulling it up in the direction indicated by the arrow.**

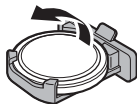

- 6 Insert a new battery with the (-) side facing up.**

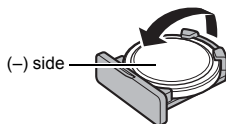

- 7 Replace the battery holder and close the cover.**

- 8 When the Date/Time menu appears, set the date and time (p. 13).**



After purchasing the camera and turning on the power for the first time, although the Date/Time menu will appear, you do not need to replace the date battery.

Camera Care and Maintenance



Never use thinners, benzine, detergents or water to clean the camera. These substances may distort or damage the equipment.

Camera Body

Gently wipe dirt off the camera body with a soft cloth or eyeglass lens wiper.

Lens

First use a lens blower brush to remove dust and dirt, then remove any remaining dirt by wiping the lens lightly with a soft cloth.



Never use organic solvents on the camera body or lens. If dirt remains, contact the closest Canon Customer Support Help Desk as listed of the European Warranty System (EWS) Booklet.

Viewfinder and LCD Monitor

Use a lens blower brush to remove dust and dirt. If necessary, gently wipe with a soft cloth or an eyeglass lens wiper to remove stubborn dirt.



Never rub or press strongly on the LCD monitor. These actions may damage it or lead to other problems.

Specifications

All data is based on Canon's standard testing methods. Subject to change without notice.

PowerShot A580 (W): Max. wide angle (T): Max. telephoto

Camera Effective Pixels	: Approx. 8 million
Image Sensor	: 1/2.5-inch type CCD (Total number of pixels: Approx. 8.3 million pixels)
Lens	: 5.8 (W) – 23.2 (T) mm (35mm film equivalent: 35 (W) – 140 (T) mm) f/2.6 (W) – f/5.5 (T)
Digital Zoom	: Approx. 4.0x (Up to approx. 16x in combination with the optical zoom)
Optical Viewfinder	: Real-image zoom viewfinder
LCD Monitor	: 2.5-inch type, amorphous silicon TFT color LCD, approx. 115,000 dots (Picture coverage 100%)
AF System	: TTL autofocus AF frame mode: Face Detect*1*2/AiAF (9 points)/Center *1 AF frame can be moved and fixed to specified face. *2 If no face is detected, AiAF (9-points) is used.
Focusing Range (From the front of the lens)	: Normal: 45 cm (1.5 ft.) – infinity Macro: 5 – 45 cm (W) (2.0 in. – 1.5 ft. (W)), 30 - 45 cm (T) (12 in. - 1.5 ft.(T)) Easy: 5 cm (2.0 in.) – infinity (W), 30 cm (12 in.) – infinity (T) Kids&Pets: 1 m (3.3 ft.) – infinity (W/T)
Shutter	: Mechanical shutter and electronic shutter
Shutter Speeds	: 1/60 – 1/2000 sec. 15 – 1/2000 sec. (Total shutter speed range. Available range varies by shooting mode.) • Slow shutter speeds of 1.3 sec. or slower operate with noise reduction.

Metering System	: Evaluative* ¹ /Center-weighted average or Spot* ² *1 Facial brightness is also evaluated in Face Detect AF. *2 Fixed to center
Exposure Compensation	: ±2 stops in 1/3-stop increments
ISO Speed (Standard Output Sensitivity, Recommended Exposure Index)	: Auto* ¹ , High ISO Auto* ² , ISO 80/100/200/400/ 800/1600 *1 Camera automatically sets the optimal speed according to shooting mode and subject brightness. *2 Camera automatically sets the optimal speed according to shooting mode, subject brightness and subject movement. However, the ISO speed is set relatively higher than Auto.
White Balance	: Auto*, Day Light, Cloudy, Tungsten, Fluorescent, Fluorescent H or Custom * The colors of faces are evaluated in Face Detect AF.
Built-in Flash	: Auto, on, off • Facial brightness is also evaluated in Face Detect AF.
Built-in Flash Range	: 30 cm – 3.5 m (12 in. – 11 ft.) (W)/ 30 cm – 2.2 m (12 in. – 7.2 ft.) (T) • Brightness of image periphery may reduce depending on shooting distance.
Shooting Modes	: Auto Easy Manual Image zone: Portrait, Landscape, Night Snapshot, Kids&Pets, Indoor, SCN Special Scene* ¹ and Movie* ² *1 Night Scene, Sunset, Foliage, Snow, Beach, Fireworks and Aquarium. *2 Standard and Compact.
Continuous Shooting	: Approx. 1.4 shots/sec.
Self-timer	: Approx. 10-sec./approx. 2-sec. delay or custom
Recording Media	: SD memory card/SDHC memory card/ MultiMediaCard/MMCplus card/HC MMCplus card
File Format	: Design rule for camera file system and DPOF compliant

Data Type	: Still images: Exif 2.2 (JPEG)* : Movies: AVI (Image data: Motion JPEG; Audio data: WAVE (monaural)) : Sound Memo: WAVE (monaural)
	* This digital camera supports Exif 2.2 (also called "Exif Print"). Exif Print is a standard for enhancing the communication between digital cameras and printers. By connecting to an Exif Print-compliant printer, the camera's image data at the time of shooting is used and optimized, yielding extremely high quality prints.
Compression	: Superfine, Fine, Normal
Number of (Still images)	: Large : 3264 × 2448 pixels
Recording	Medium 1 : 2592 × 1944 pixels
Pixels	Medium 2 : 2048 × 1536 pixels
	Medium 3 : 1600 × 1200 pixels
	Small : 640 × 480 pixels
	Date Stamp : 1600 × 1200 pixels
	Widescreen : 3264 × 1832 pixels
(Movies)	: Standard : 640 × 480 pixels (20 frames/sec.) : 640 × 480 pixels (20 frames/sec. LP) : 320 × 240 pixels (30 frames/sec.) Recording can continue until the memory card is full*1 (can record up to a maximum of 4 GB per clip*2)
	: Compact: 160 × 120 pixels (15 frames/sec.) Maximum recording length per clip: 3 min.
	*1 Using super high-speed memory cards (SDC- 512 MSH recommended).
	*2 Even if the file size has not reached 4 GB, the recording is stopped when the recording time reaches one hour. Depending on memory card capacity and data write speed, recording may stop before the file size reaches 4 GB or the recording time reaches one hour.

Playback Modes	: Single (histogram displayable), Index (9 thumbnail images), Magnified (approx. 2x to 10x max.), Resume Playback, Image Inspection Tool, Jump, My Category, Movie Playback (slow motion available), Rotate, Slide Show, Red-Eye Correction, Resize, Sound memos (it is possible to record and playback up to 1 min.), Protect
Direct Print	: PictBridge compliant, and Canon Direct Print and Bubble Jet Direct compatible
Interface	: Hi-Speed USB (mini-B) Audio/Video output (NTSC or PAL selectable, monaural audio)
Communication Settings	: MTP, PTP
Power Source	: 2 AA-size alkaline batteries 2 AA-size NiMH batteries NB4-300 (sold separately) AC Adapter Kit ACK800 (sold separately)
Operating Temperatures	: 0 – 40 °C (32 – 104 °F) (0 – 35 °C (32 – 95 °F) when NB-3AH is used.)
Operating Humidity	: 10 – 90%
Dimensions (excluding protrusions)	: 94.3 × 64.7 × 40.8 mm (3.71 × 2.55 × 1.61 in.)
Weight (camera body only)	: Approx. 175 g (6.17 oz.)

Battery Capacity

	Number of Images Shot	Playback Time
	LCD Monitor On (Based on the CIPA standard)	
AA-size Alkaline Batteries (included with the camera)	Approx. 220 images	Approx. 9 hours
AA-size NiMH Batteries (NB-3AH (fully charged))	Approx. 500 images	Approx. 11 hours

- The actual figures will vary according to the shooting conditions and settings.
- Movie data is excluded.
- At low temperatures, the battery performance may diminish and the low battery icon (blinking red) may appear very rapidly. In these circumstances, the performance can be improved by warming the battery in a pocket before use.

Test Conditions

Shooting: Normal temperature (23 °C ±2°C/73 °F ±3.6 °F), normal relative humidity (50% ±20%), alternating wide angle end and telephoto end shots at 30 second intervals with the flash fired once every two shots and the camera power turned off after every tenth shot. Power is left off for a sufficient amount of time*, then the power is turned back on and the testing procedure is repeated.

• A Canon-brand memory card is used.

* Until the battery returns to normal temperature





















Playback: Normal temperature (23 °C ±2 °C/73 °F ±3.6 °F), normal relative humidity (50% ±20%), continuous playback at 3 seconds per image.



See *Battery* (p. 164).

Memory Cards and Estimated Capacities







: Memory card included with the camera

Recording Pixels	Compression	32 MB	SDC-128M	SDC-512MSH
L (Large) 3264 × 2448 pixels		8	35	139
		14	59	231
		30	123	479
M1 (Medium 1) 2592 × 1944 pixels		11	49	190
		21	87	339
		42	173	671
M2 (Medium 2) 2048 × 1536 pixels		18	76	295
		33	136	529
		66	269	1041
M3 (Medium 3) 1600 × 1200 pixels		30	121	471
		53	217	839
		102	411	1590
S (Small) 640 × 480 pixels		114	460	1777
		177	711	2747
		278	1118	4317
 (Date Stamp) 1600 × 1200 pixels		53	217	839
W (Widescreen) 3264 × 1832 pixels		11	47	183
		19	79	307
		41	166	642

This reflects standard shooting criteria established by Canon. Actual results may vary according to the subject and shooting conditions.

Movie

: Memory card included with the camera

	Recording Pixels/ Frame Rate	32 MB	SDC-128M	SDC-512MSH
 Standard	 640 × 480 pixels 20 frames/sec.	23 sec.	1 min. 36 sec.	6 min. 12 sec.
	 640 × 480 pixels 20 frames/sec. LP	47 sec.	3 min. 10 sec.	12 min. 16 sec.
	 320 × 240 pixels 30 frames/sec.	44 sec.	3 min. 1 sec.	11 min. 42 sec.
 Compact	 160 × 120 pixels 15 frames/sec.	3 min. 36 sec.	14 min. 29 sec.	55 min. 57 sec.

















• Maximum movie clip length at : 3 min. The figures indicate the maximum continuous recording time.

Image Data Sizes (Estimated)

Recording Pixels	Compression		
			
 3264 × 2448 pixels	3436 KB	2060 KB	980 KB
 2592 × 1944 pixels	2503 KB	1395 KB	695 KB
 2048 × 1536 pixels	1602 KB	893 KB	445 KB
 1600 × 1200 pixels	1002 KB	558 KB	278 KB
 640 × 480 pixels	249 KB	150 KB	84 KB
 1600 × 1200 pixels	–	558 KB	–
 3264 × 1832 pixels	2601 KB	1540 KB	736 KB

	Recording Pixels/Frame Rate	File size
 Standard	 640 × 480 pixels 20 frames/sec.	1280 KB/sec.
	 640 × 480 pixels 20 frames/sec. LP	640 KB/sec.
	 320 × 240 pixels 30 frames/sec.	660 KB/sec.
 Compact	 160 × 120 pixels 15 frames/sec.	120 KB/sec.

MultiMediaCard

Interface	Compatible with MultiMediaCard standards
Dimensions	32.0 × 24.0 × 1.4 mm (1.26 × 0.94 × 0.06 in.)
Weight	Approx. 1.5 g (0.05 oz.)

SD Memory Card

Interface	Compatible with SD memory card standards
Dimensions	32.0 × 24.0 × 2.1 mm (1.26 × 0.94 × 0.08 in.)
Weight	Approx. 2 g (0.07 oz.)

NiMH Battery NB-3AH

(Supplied with the separately sold NiMH Battery NB4-300 set or the Battery and Charger Kit CBK4-300)

Type	AA-size nickel metal hydride battery
Nominal Voltage	1.2 V DC
Typical Capacity	2500 mAh (min.: 2300 mAh)
Cycle Life	Approx. 300 times
Operating Temperatures	0 – 35 °C (32 – 95 °F)
Diameter × Length	14.5mm × 50.0 mm (0.57 × 1.97 in.)
Weight	Approx. 30 g (1.06 oz.)

Battery Charger CB-5AH/CB-5AHE

(Supplied with the separately sold Battery and Charger Kit CBK4-300)

Rated Input	100 – 240 V AC (50/60 Hz)
Rated Output	565 mA ×4, 1275 mA ×2
Charging Time	Approx. 4 hours 40 min.* ¹ , Approx. 2 hours* ²
Operating Temperatures	0 – 35 °C (32 – 95 °F)
Dimensions	65.0 × 105.0 × 27.5 mm (2.56 × 4.13 × 1.08 in.)
Weight	Approx. 95 g (3.35 oz.)

*1 When charging four NB-3AH batteries

*2 When charging two NB-3AH batteries loaded one on each side of the battery charger

Compact Power Adapter CA-PS800

(Included with the separately sold AC Adapter Kit ACK800)

Rated Input	100 – 240 V AC (50/ 60 Hz)
Rated Output	3.15 V DC, 2.0 A
Operating Temperatures	0 – 40 °C (32 – 104 °F)
Dimensions	42.6 × 104.0 × 31.4 mm (1.68 × 4.09 × 1.24 in.)
Weight	Approx. 180 g (6.35 oz.) (excluding power cord)

Index

Numerics

3:2 Guide 99

A

AC Adapter Kit ACK800 170
 Accessories 36
 AF Frame 46, 82
 AF-assist Beam 40, 49
 AF-Point Zoom 78
 Auto Category 100
 AUTO Mode 15
 Auto Rotate 139

B

Battery
 Installing 10
 Low Battery 47
 Battery Capacity 180

C

Camera Shake Warning 146
 Card
 Formatting 134
 Components Guide 40
 Compression 64
 Computer
 Connecting 29
 Downloading Images 27
 System Requirements 27
 Continuous Shooting 75
 Create Folder 137

D

Date and Time 13

Date Battery 173
 Date Stamp 22
 Digital Tele- Converter 55
 Digital Zoom 55
 Direct Print Compatible
 Printers 35, 38
 Direct Transfer 31
 Display Language 14
 Display Overlays 99
 DPOF Print Settings 126
 Drive Mode 46

E

Easy Mode 17
 Embedding the Date in the Image
 Data 22
 Erase all 125
 Erasing 19, 125
 Exif Print 178

F

Face Detect 82
 Face Select and Track 84
 File Numbering 135
 Flash
 Settings 76
 Shooting 59
 Focus 80, 82
 Focus Check 53, 80
 Focus Check Display 105
 Focus Lock 86
 Frame Rates 74

G

Grid Lines 99

H

- High-Power Flash 171
- Histogram..... 48

I

- Index Playback..... 104
- Indicators 43
- ISO Speed 65

J

- Jump (Searching the Images).. 107

L

- LCD Monitor Display 53
- Lens Retract..... 52
- List of Messages 154

M

- Macro 60
- Memory Cards
 - Estimated Capacities 181
- Menu
 - FUNC. Menu 48
 - Play Menu 50
 - Print Menu 50
 - Rec. Menu 49
 - Set up Menu 51
 - Settings 44
- Metering Mode 91
- Microphone 24
- Mode Dial..... 66
- Movie
 - Shooting..... 24, 71
 - Viewing 26
- Mute 51
- My Category..... 109
- My Colors..... 97

N

- Night Display 54

O

- Overexposure Warning..... 54

P

- Power Kits 167
- Power Saving 51, 132
- Pressing fully 16
- Pressing halfway 15
- Print List..... 21
- Print Method 52
- Print/Share Button 42, 101
- Printing 20
- Protect 124

R

- Rec. Review 16
- Recording Pixels..... 63, 74
- Red-Eye Correction
 - (Playback)..... 115
- Red-Eye Correction (Shooting) . 76
- Red-Eye Reduction 76
- Registering Settings 101
- Reset All 140
- Resize..... 120
- Resume 18
- Review 49
- Review Info..... 80
- Rotate 112

S

- Safety Zoom 56
- Self-Timer 61
- Shooting Mode 66
 - Functions Available 189
- Shutter button 15

Slide Shows	114
Sound Memos	122
Start-up Image	51
System Map	34

T

Telephoto	55
Transfer Settings (DPOF)	130
Transition	113
TV Set	141

V

Video Output Signal	141
Viewfinder	41
Volume	51

W

White Balance	94
Wide Angle	55
Wrist Strap	12

Disclaimer



- While every effort has been made to ensure that the information contained in this guide is accurate and complete, no liability can be accepted for any errors or omissions.
- Canon reserves the right to change the specifications of the hardware and software described herein at anytime without prior notice.
- No part of this guide may be reproduced, transmitted, transcribed, stored in a retrieval system, or translated into any language in any form, by any means, without the prior written permission of Canon.
- Canon makes no warranties for damages resulting from corrupted or lost data due to a mistaken operation or malfunction of the camera, the software, SD memory cards (SD cards), personal computers, peripheral devices, or use of non-Canon SD cards.



Trademark Acknowledgments

- Microsoft, Windows Vista and the Windows Vista logo are trademarks or registered trademarks of Microsoft Corporation in the United States and/or other countries.
- Macintosh, the Mac logo, QuickTime and the QuickTime logo are trademarks of Apple Inc., registered in the U.S. and other countries.
- The SDHC logo is a trademark.

Functions Available in Each Shooting Mode

Some functions may not be available, depending on the shooting mode. Check the functions available for each shooting mode in the table below.

Function		Shooting Mode						
		Long Shutter						
Exposure Compensation (p. 90)				<input type="radio"/>	<input type="radio"/>	<input type="radio"/>	<input type="radio"/>	
Long Shutter Mode (p. 92)				<input type="radio"/>	<input type="radio"/>	<input type="radio"/>	<input type="radio"/>	
ISO Speed (p. 65)	Auto ¹⁾			<input type="radio"/>	<input type="radio"/>	<input type="radio"/>	<input type="radio"/>	
	High ISO Auto			<input type="radio"/>	<input type="radio"/>	<input type="radio"/>	<input type="radio"/>	
	ISO 80 – 1600			<input type="radio"/>	<input type="radio"/>	<input type="radio"/>	<input type="radio"/>	
White Balance (p. 94)	Auto ¹⁾			<input type="radio"/>	<input type="radio"/>	<input type="radio"/>	<input type="radio"/>	
	Other than Auto			<input type="radio"/>	<input type="radio"/>	<input type="radio"/>	<input type="radio"/>	
Drive Mode (pp. 61, 75)	Single Shot			<input type="radio"/>	<input type="radio"/>	<input type="radio"/>	<input type="radio"/>	
	Continuous			<input type="radio"/>	<input type="radio"/>	<input type="radio"/>	<input type="radio"/>	
	Self-timer	2 sec./10 sec.			<input type="radio"/>	<input type="radio"/>	<input type="radio"/>	<input type="radio"/>
		Custom			<input type="radio"/>	<input type="radio"/>	<input type="radio"/>	<input type="radio"/>
My Colors (p. 97)				<input type="radio"/>	<input type="radio"/>	<input type="radio"/>	<input type="radio"/>	
Metering System (p. 91)	Evaluative			<input type="radio"/>	<input type="radio"/>	<input type="radio"/>	<input type="radio"/>	
	Center-weighted Average			<input type="radio"/>	<input type="radio"/>	<input type="radio"/>	<input type="radio"/>	
	Spot			<input type="radio"/>	<input type="radio"/>	<input type="radio"/>	<input type="radio"/>	
Number of Recording Pixels, Compression (still images) (pp. 63, 64)				<input type="radio"/>	<input type="radio"/>	<input type="radio"/>	<input type="radio"/>	
Date Stamp (Date, Date & Time) (p. 22)				<input type="radio"/>	<input type="radio"/>	<input type="radio"/>	<input type="radio"/>	
Number of Recording Pixels, Frame Rate, Compression (movies) (p. 71)	640 × 480, 20 fps / 20 fps LP			<input type="radio"/>	<input type="radio"/>	<input type="radio"/>	<input type="radio"/>	
	320 × 240, 30 fps			<input type="radio"/>	<input type="radio"/>	<input type="radio"/>	<input type="radio"/>	
	160 × 120, 15 fps			<input type="radio"/>	<input type="radio"/>	<input type="radio"/>	<input type="radio"/>	
AE Lock (p. 88)				<input type="radio"/>	<input type="radio"/>	<input type="radio"/>	<input type="radio"/>	
FE Lock (p. 89)				<input type="radio"/>	<input type="radio"/>	<input type="radio"/>	<input type="radio"/>	
AF Lock (p. 86)				<input type="radio"/>	<input type="radio"/>	<input type="radio"/>	<input type="radio"/>	
Shooting Zone (p. 60)	Normal			<input type="radio"/>	<input type="radio"/>	<input type="radio"/>	<input type="radio"/>	
	Macro			<input type="radio"/>	<input type="radio"/>	<input type="radio"/>	<input type="radio"/>	
Face Select and Track (p. 84)				<input type="radio"/>	<input type="radio"/>	<input type="radio"/>	<input type="radio"/>	
Flash (p. 59)	Auto			<input type="radio"/>	<input type="radio"/>	<input type="radio"/>	<input type="radio"/>	
	On			<input type="radio"/>	<input type="radio"/>	<input type="radio"/>	<input type="radio"/>	
	Off			<input type="radio"/>	<input type="radio"/>	<input type="radio"/>	<input type="radio"/>	
LCD Monitor Setting (p. 53)	LCD Monitor (off)			<input type="radio"/>	<input type="radio"/>	<input type="radio"/>	<input type="radio"/>	
	LCD Monitor (no information)			<input type="radio"/>	<input type="radio"/>	<input type="radio"/>	<input type="radio"/>	
	LCD Monitor (information view)			<input type="radio"/>	<input type="radio"/>	<input type="radio"/>	<input type="radio"/>	

Function		Shooting Mode				
		Long Shutter				
AF Frame (p. 82)	Face Detect	○	○	○	○	○
	AiAF (9-point)	○	○	○	○	—
	Center	○	○	○	○	—
AF-Point Zoom (p. 78)		○	○	○	○	—
Digital Zoom ⁴⁾ (p. 55)	Standard	○	○	○	○	○ ⁵⁾
	Digital Tele-converter	○	○	○	○	—
Flash Settings (p. 76)	Slow Synchro	○	○ ⁵⁾	—	—	—
	Red-Eye Correction	○	○	○	○	—
	Red-Eye Lamp	○	○	○	○	○ ⁵⁾
Custom Timer (delay, shots) (p. 61)		○	○	○	○	—
AF-assist Beam (p. 49)		○	○	○	○	○ ⁶⁾
Review (Rec. review) (p. 49)		○	○	○	○	— ⁸⁾
Review Info. (p. 16)	Off	○	○	○	○	○
	Detailed/Focus Check	○	○	○	○	—
Auto Category (p. 100)		○	○	○	○	○ ⁵⁾
Disp. Overlay (p. 99)	Grid Lines	○	○	○	○	—
	3:2 Guide/Both	○	○	○	○	—
Registering settings to the Print/Share button (p. 101)		○	○	○	○	—

○ : Setting available or optimum value is automatically set by the camera.

— : Not available.

- 1) Set to optimum value depending on each shooting mode.
- 2) Recording pixels fixed to Large, compression fixed to Fine.
- 3) Including macro.
- 4) Date stamp and Widescreen are not available.
- 5) Always set to on.
- 6) Always set to [On] when Auto Flash is selected.
- 7) Only available when the flash is set to [On].
- 8) Fixed to 2 seconds.

Canon