

Canon

Zoemini C



Instant Camera Printer
User Manual

CONTENTS

SAFETY INFORMATION	P3
OVERVIEW	P4
Supplied Items	
Product Features	
SETUP	P5-8
Charge	
Load Paper	
External Memory	
OPERATION	P9-12
Power ON/OFF	
Taking A Photo	
Viewfinder	
Aspect Ratio	
Printing and Reprint	
LED Indicator	
Troubleshooting	
SPECIFICATIONS	P13

SAFETY INFORMATION

READ BEFORE USE

Please read the following instructions and safety precautions before using the device.

For regulatory and additional safety information, refer to the Regulation and Warranty Information sheet included in your package contents.

RMN: PP3001

Regulatory Model Identification Number is assigned for regulatory identification purpose.

WARNING

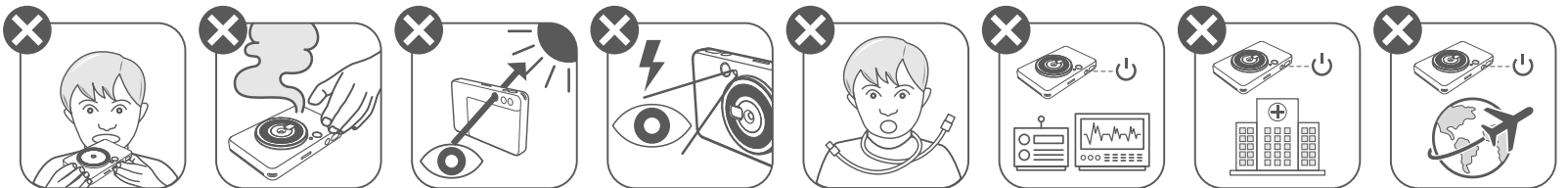

- Keep away from children and infants. Improper use of this product may cause suffocation or accident.
- Stop using the device immediately if it emits smoke or a strange smell, or otherwise behaves abnormally.
- Do not look at the sun or bright lights through the viewfinder or the lens. Blindness or vision problems could result.
- Do not fire the flash near the eyes. It may hurt the eyes.
- A strap wound around a child's neck may result in asphyxiation. If your product uses a power cord, mistakenly winding the cord around a child's neck may result in asphyxiation.
- Turn the device off in places where camera use is prohibited. The electromagnetic waves emitted by the camera may interfere with the operation of electronic instruments and other devices. Exercise adequate caution when using the product in places where use of electronic devices is restricted, such as inside airplanes and medical facilities.

CAUTION

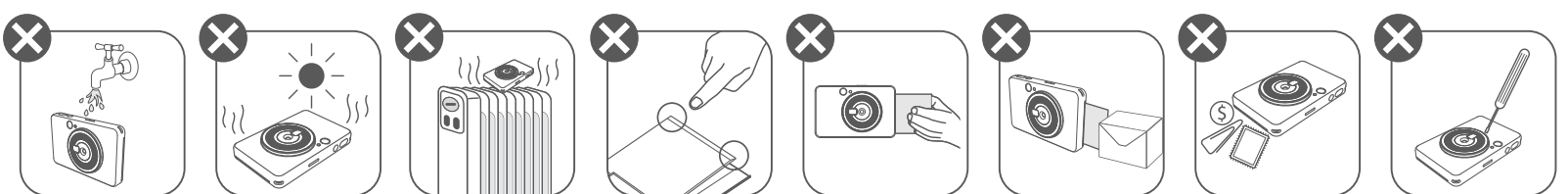

- When operating in extreme weather, the device might not print. Let the printer temperature adjust to the recommended operating temperature of 15° to 32°C, before attempting to print again.
- When charging, please charge the device at the recommended temperature of 15° to 32°C.
- Use a soft dry cloth to clean the device. Do not clean with a damp cloth or volatile liquids such as paint thinner.
- Keep the top cover closed to avoid dust and other particles from entering the inside of the device.
- If the device is not functioning properly, please contact the dealer you purchased this product from or Canon Service & Support at <https://www.canon-europe.com/support>
- Never expose the battery to high temperatures, direct heat, or dispose by incineration.
- Electromagnetic interference or electrostatic discharge may cause the device to malfunction or the memory to be lost or altered. Should this occur, use a pin, or similar item to press the [RESET] button at the bottom of the device.

OVERVIEW

SUPPLIED ITEMS

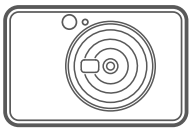

Instant Camera Printer



Quick Start Guide



Regulation and
Warranty
Information sheet

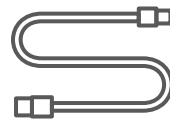

USB Cable



CANON ZINK™
Photo Paper
(10 sheets)



Wrist Strap

PRODUCT FEATURES

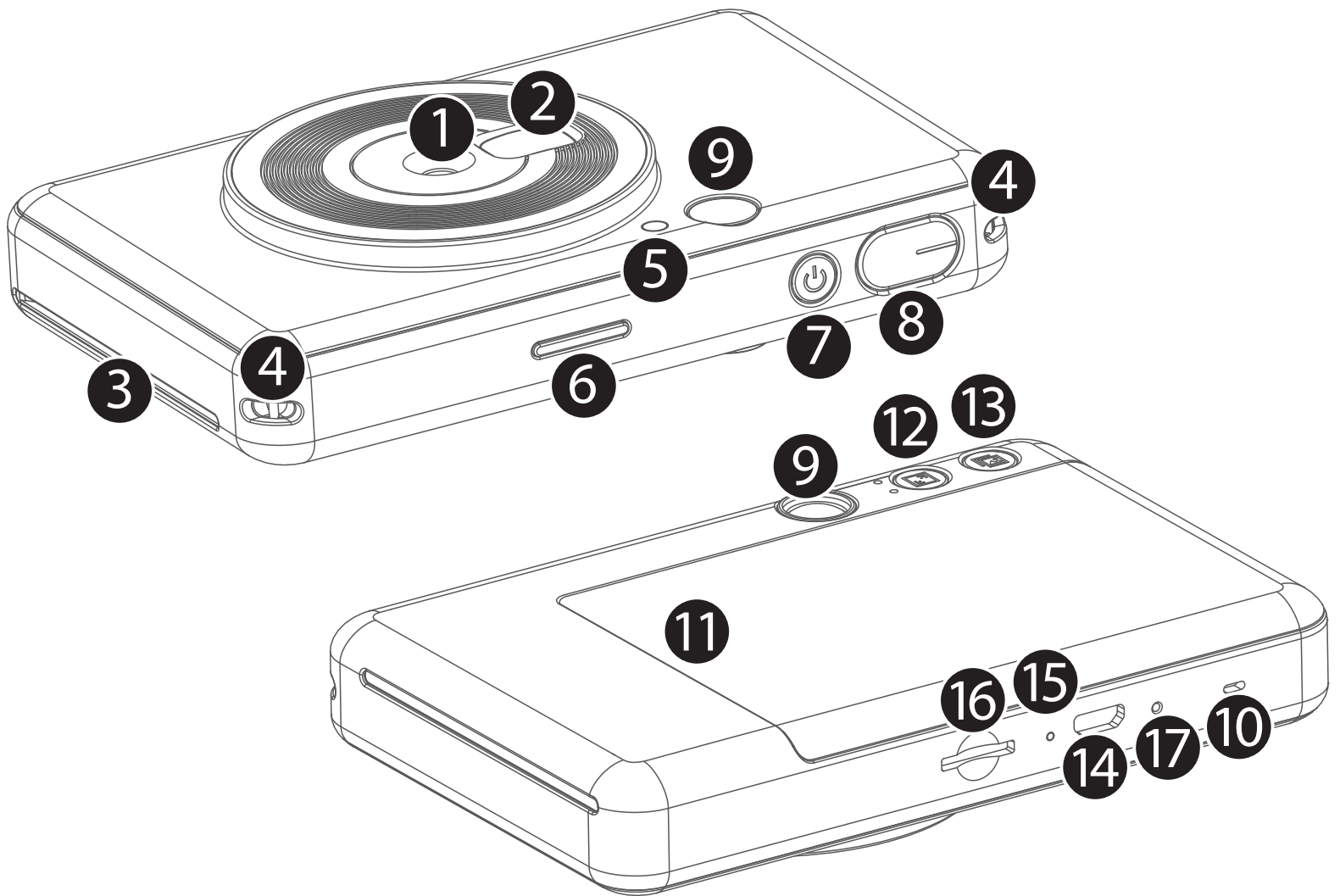

- 1 Camera Lens
 - 2 Selfie Mirror
 - 3 Print Output Slot
 - 4 Strap Hole
 - 5 Flash
 - 6 Status LED
 - 7 Power Button
 - 8 Shutter Button
 - 9 Viewfinder
 - 10 Speaker
 - 11 Printer Cover
 - 12 Aspect Ratio Button
 - 13 Reprint Button
 - 14 Micro USB Port
 - 15 Charging Status LED
 - 16 MicroSD Card Slot (up to 256GB)
 - 17 Reset Button
- * To reset the device, press with a pin

SETUP

CHARGING

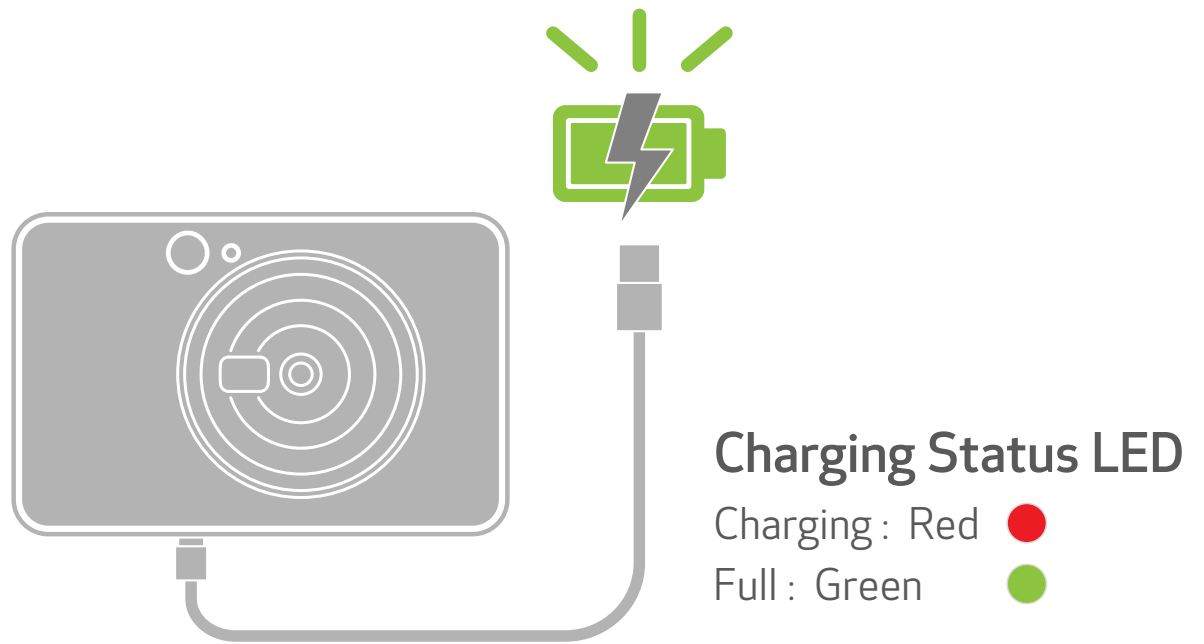

The device has a built-in battery. Please fully charge the device via the USB cable provided before using.

- 1 Insert the smaller end of the supplied USB cable into the device and other end into a chargeable USB adapter.
- 2 The charging LED light will turn red to indicate charging.
- 3 Once fully charged, the charging LED will turn green.
 - Operating time may vary depending on the battery status, operational status and environment conditions.

! NOTE

About USB Cable

HANDLE THE USB CABLE WITH CARE WHILE CHARGING

- Do not place any heavy objects on top of the cable.
- Do not place the USB cable near heat.
- Do not scratch, damage, twist or pull hard on the cable.
- Do not plug or unplug the cable with wet hands.
- Avoid too high/too low temperature or humid conditions.
- Please unplug the USB cable from power source after charging.
- Please use the supplied USB cable for charging.

LOAD PAPER

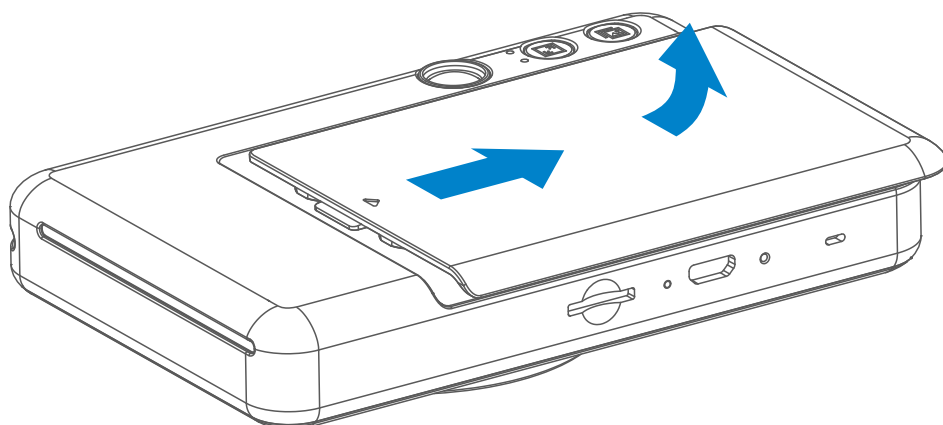

- 1 Remove the cover by sliding it forward in the direction of the arrow.

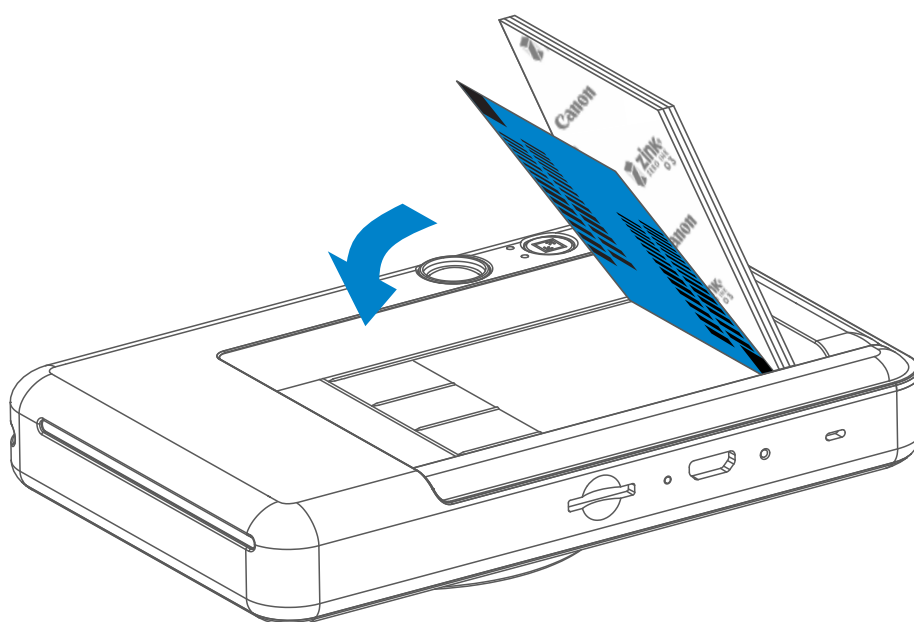

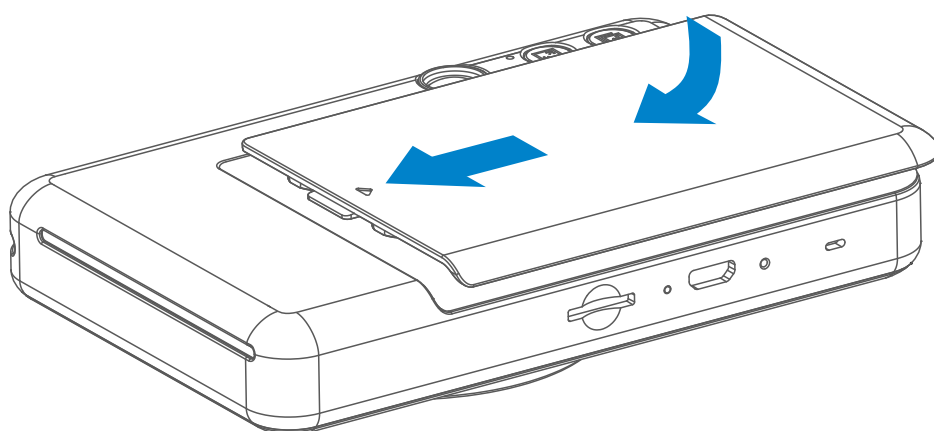

- 2 Open a single pouch of photo paper (10 sheets + blue SMART SHEET™).
- 3 Place all 10 photo paper sheets and the one SMART SHEET™ into the photo paper compartment.
 - Stack the photo paper on top of the blue SMART SHEET™, making sure the blue barcode and the photo paper logos are facing down.

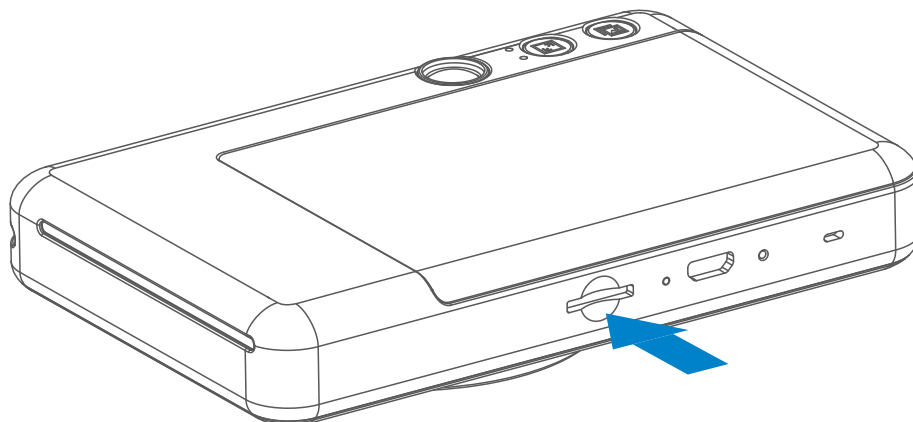

- 4 Place the top cover back onto the device. It should click into place when closed properly.
 - The blue SMART SHEET™ will be sent through the device automatically before the first print.

EXTERNAL MEMORY



 An external MicroSD card (up to 256 GB) is needed for saving captured photos. Only FAT16, FAT32 and exFAT format are supported.

PREPARING A MEMORY CARD

Use the following memory cards (sold separately)

- MicroSD memory cards *1
- MicroSDHC memory cards *1 *2
- MicroSDXC memory cards *1 *2

*1 Cards conforming to SD standards. However, not all memory cards have been verified to work with the camera.

*2 UHS-I memory cards are also supported.

INSTALL AND REMOVE THE MicroSD CARD

- Insert the MicroSD card into the slot at the bottom of the device. You will feel a slight click when the card is fully inserted .
- Push on the top of the card to release it. Gently pull to fully remove the card from the device.
- If there is an error on reading /writing to the MicroSD card, remove the MicroSD card and restart the device.
- Connect the device to a computer by USB cable. Double-click the external drive image when it appears on the computer to view and save the photos.

NOTE

MAINTAINING THE DEVICE

- Use and keep the device in the recommended environment of 15° to 32° C and 40-55% relative humidity.

WHEN USING PHOTO PAPER



- Only load 10 ZINK™ photo paper sheets and 1 SMART SHEET™. Do not load more as it can result in paper jams or printing errors.
- If there is a paper jam, simply turn the printer OFF and ON to automatically clear the paper jam. Don't try to pull the paper out.
- While the device is printing, don't pull or tug on the photo paper.
- Handle photo paper carefully to avoid damage or bending.
- Keep the photo paper clean when loading. If photo paper is dirty or damaged, it may result in a paper jam or print error.
- Don't open a new pouch of photo paper until you are ready to load it into your device.
- Don't expose photo paper to direct sunlight or moisture.
- Don't leave your photo paper in an area where the temperature or humidity is out of the suggested conditions indicated on the pouch. It may reduce the quality of the printed photo.

ABOUT THE SMART SHEET™

- Each pouch of photo paper contains 10 sheets of photo paper and 1 blue SMART SHEET™.
- Load the SMART SHEET™ and photo paper from within the same pouch for optimal print quality. Each SMART SHEET™ is specifically tuned for the pouch of paper it is contained in.
- The SMART SHEET™ will be sent through the device automatically before the first print to clean the printer and optimize print quality for that specific paper pouch (10 sheets).
- Keep the SMART SHEET™ and only discard after you have printed all 10 sheets of photo paper in the pouch. If print quality is not as expected, you can reuse the SMART SHEET™ if the paper is still from the same pouch. Simply slide the SMART SHEET™ with its barcode-side down underneath the remaining photo paper.
- Using a SMART SHEET™ from another pouch may result in reduced print quality.

OPERATION

POWER ON/OFF

- 1 Press and hold the Power button  until the LED indicator light turns on.
- 2 When the LED indicator turns to a steady white, the device is ready to use.
- 3 Press and hold the Power button  to turn off the device.

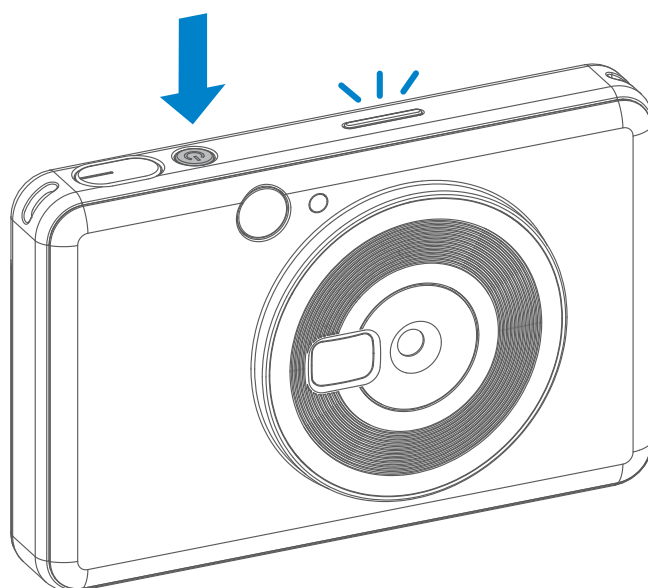

AUTO POWER OFF

- When the device is idle for about 5 minutes, it will automatically power off. The user can resume the device by pressing the Power button again.

TAKING A PHOTO

- 1 Hold the device, confirm the desired composition of the image.
- 2 Press the Shutter button  to take a photo.

The camera will automatically trigger the flash if it is necessary for the lighting conditions.

Use the reflective plate besides the lens as a self-portrait mirror for selfie.

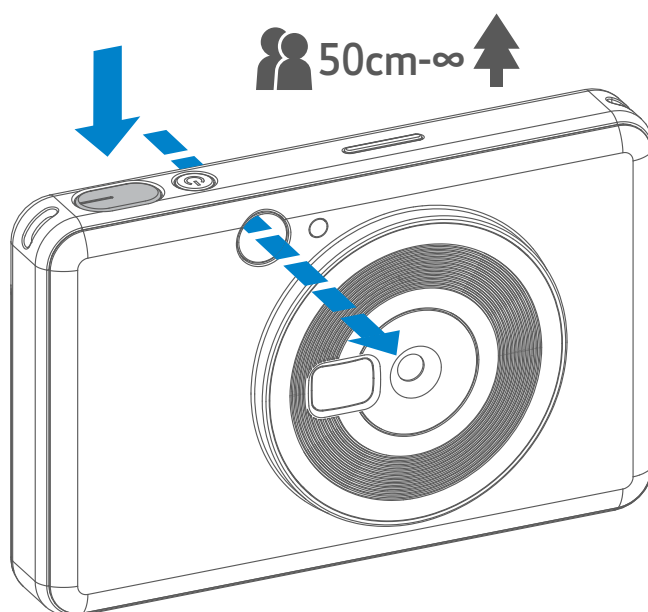

VIEWFINDER

Compose an image with the frame mark in the viewfinder.

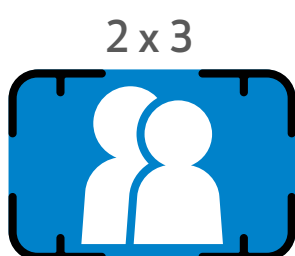
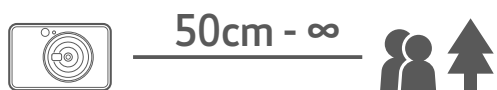

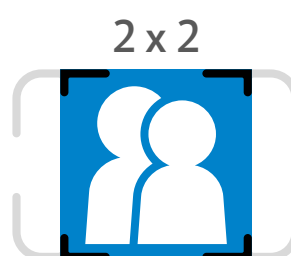

2 X 3 Frame Mark
for normal shooting
at 1m - ∞

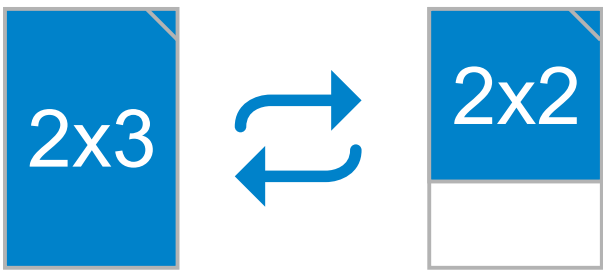

2 X 2 Frame Mark
for normal shooting
at 1m - ∞

ASPECT RATIO



The user can choose between two aspect ratios, 2x3 and 2x2 with the Aspect ratio button .

Aspect ratio can be changed at any time before taking a photo.

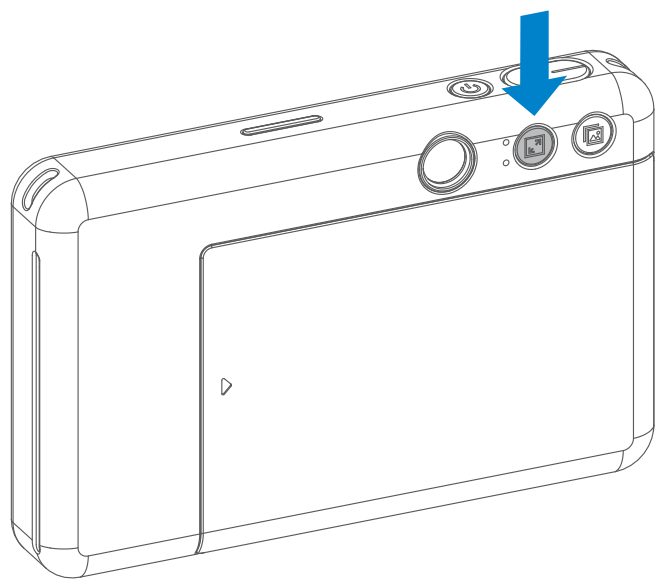

When the aspect ratio is 2x2, the blank area of the photo paper is different. It is based on how the device is being held.

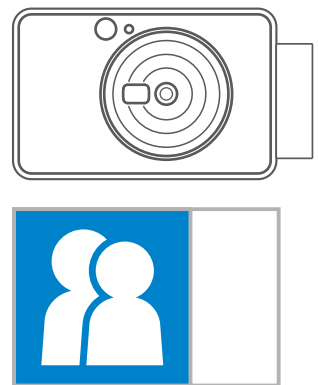
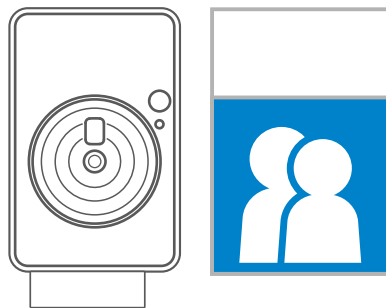
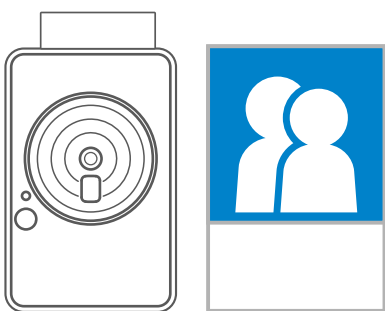

PRINTING AND REPRINT

PRINTING A PHOTO







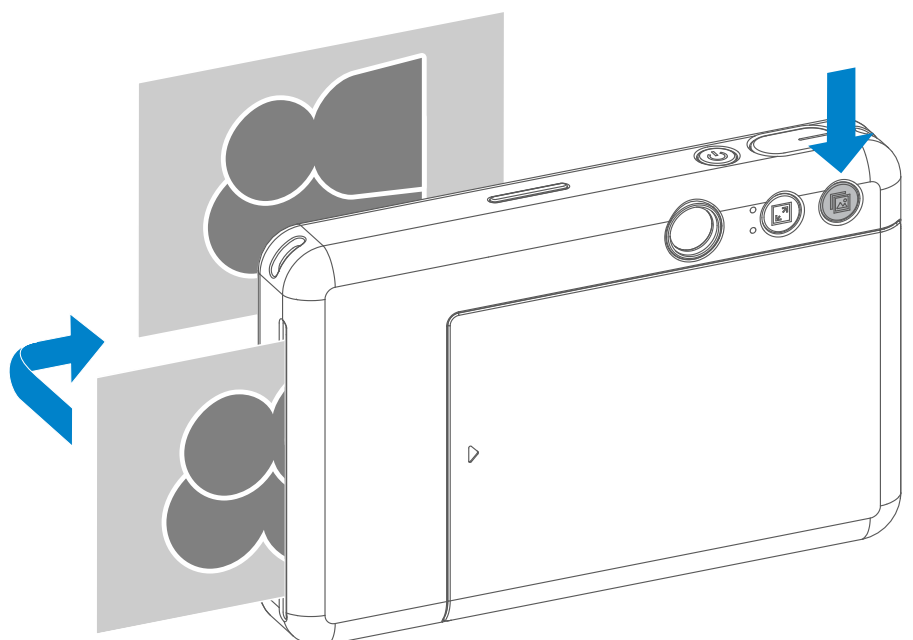

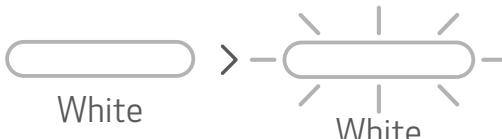

- The photo will be printed out immediately after taking the photo.
- The device can hold up to 3 images at a time to print.

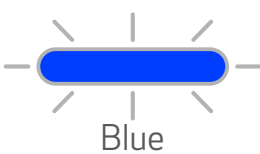

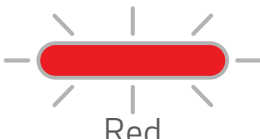
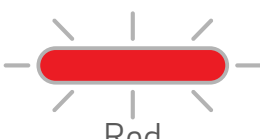
REPRINT A PHOTO

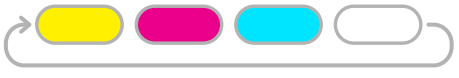
When you have captured a photo and it is printed out, if you want to duplicate the same photo or distribute several pieces of the same photos in a party, you can just simply press the Reprint button  to reprint the last printed photo.

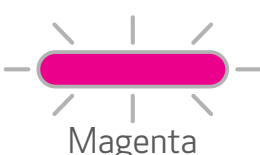

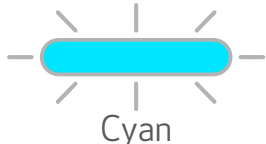

LED INDICATOR

Status	Operation / Situation	LED Indicator
Power On	Press and hold the Power Button	 White > White
Standby	After the device is powered on	 White
Power Off	Press and hold the Power Button	 Off
SMART SHEET™ Error	When the device detects wrong SMART SHEET™ is inserted, or other SMART SHEET™ error	 Blue
Processing SMART SHEET™	When the device is printing out SMART SHEET™	 White
No Paper	When the device has no paper, the device will not allow for taking a photo	 Red
Paper Jam/ Cover Open	When there is a paper jam or the printer cover is opened	 Red
Get Ready for Printing	Preparing for printing	 White
Printing Photo	When the device is printing a photo	 Yellow > Magenta > Cyan > White (Looping)
MS Mode (Mass Storage Mode)	Device is connected to a computer	 Magenta
MicroSD Card Error	Cannot write data into MicroSD Card	 Magenta
Temperature Too High	When the device temperature is too high	 Red (Until temperature returns to normal)
Temperature Too Low	When the device temperature is too low	 Cyan (Until temperature returns to normal)

Status	Operation / Situation	LED Indicator
Printer Head Cooling	Checking the printer head temperature and letting it cool down before printing	 Cyan
Low Battery	When battery level is down to 20%	 White > Red (Looping)
Very Low Battery	When battery level is very low	 Red > White (Looping)

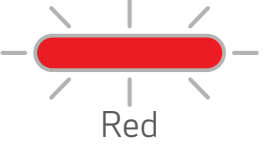
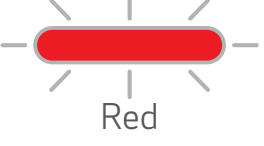
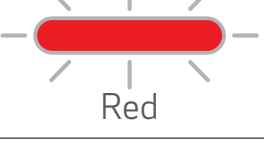
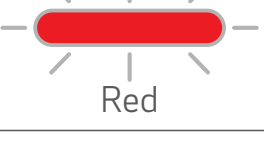
TROUBLESHOOTING

Status	LED Indication	Actions
MicroSD Card Error	 Magenta	<ul style="list-style-type: none"> • Check if the MicroSD card is inserted properly • Check if the MicroSD card is full • Check if the MicroSD card is corrupted • Check if the MicroSD card is compatible
Paper Feeding Failed	 Red	<ul style="list-style-type: none"> • Open the paper compartment cover to check if Canon ZINK™ photo paper is inserted
Paper Jam	 Red	<ul style="list-style-type: none"> • Power off and on the device, the photo paper will be fed out automatically
No Paper	 Red	<ul style="list-style-type: none"> • Reload Canon ZINK™ photo paper into the device
Printer Cover is not closed properly	 Red	<ul style="list-style-type: none"> • Close the printer cover properly
Overheat	 Red	<ul style="list-style-type: none"> • Wait until the device temperature returns to normal, the device will resume working again
Device does not Work	N/A	<ul style="list-style-type: none"> • Make sure the battery level is not too low. If it is, recharge the device
Take a Photo	N/A	<ul style="list-style-type: none"> • Make sure print queue buffer is available • Make sure device has Canon ZINK™ photo paper

SPECIFICATIONS

Printing Technology	ZINK™
Printing Resolution	314 x 500 dpi (dots per inch)
Printing Speed	Approximately 50 seconds - Motor starts and stops, at room temperature 25° C
Photo Aspect Ratio	2" x 2" or 2" x 3"
Compatible Paper	Canon ZINK™ Photo Paper : ZP-2030-20 (20 sheets) ZP-2030-50 (50 sheets) 2" x 3" / Peel-and-Stick Back
Paper Capacity	Up to 10 sheets of ZINK™ photo paper + 1 SMART SHEET™
Photo Resolution	5MP
Focal Length	24 mm
Aperture	f / 2.4
Focusing Range	50cm - ∞
Sensitivity	Auto (ISO 100 - 1600)
Flash	YES (Auto)
Flash Range	0.5m - 1.0m
Memory Card	MicroSD Card, up to 256GB
Power Source	Built-in Rechargeable Li-Polymer Battery 700mAh, 7.4V
Charging Speed	Approximately 90 minutes (Full Charge)
Power Adapter	Output Current : 1.6A (min) Voltage : 5V
Environmental Parameters	- Recommended Printing Operating, Charging, and Storage Temperature : 15° to 32° C - Recommended Printing Operating, Charging, and Storage Humidity : 40-55% RH - Operating Temperature : 5° to 40° C - Operating Humidity : < 70% RH
Automatic Power-off	5 minutes
Dimension	121mm (W) x 78.3mm (H) x 23.7mm (D)
Weight	170 g
Compatible OS (for Computer)	Windows 7 / 8 / 8.1 / 10 Mac OSX 10.10 - 10.14
Connection for Charging and Data Transfer	USB 2.0 (Micro USB)

Subject to change without notice

Canon