

Canon

 imageFORMULA
Flatbed Scanner Unit 102

User Manual

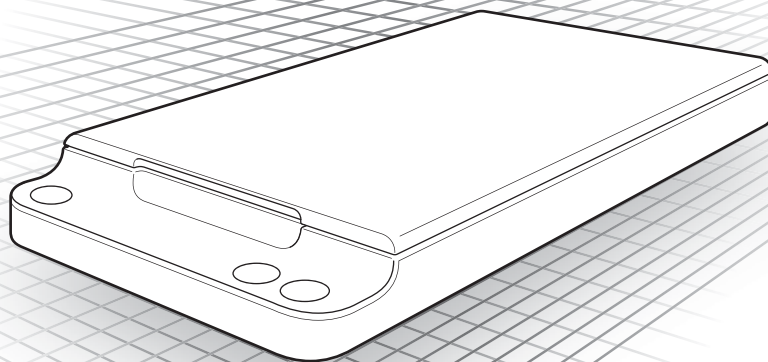

- Please read this manual before operating this scanner.
- After you finish reading this manual, store it in a safe place for future reference.

■ European Union (and EEA) only.



This symbol indicates that this product is not to be disposed of with your household waste, according to the WEEE Directive (2002/96/EC) and your national law.

This product should be handed over to a designated collection point, e.g., on an authorized one-for-one basis when you buy a new similar product or to an authorized collection site for recycling waste electrical and electronic equipment (EEE). Improper handling of this type of waste could have a possible negative impact on the environment and human health due to potentially hazardous substances that are generally associated with EEE. At the same time, your cooperation in the correct disposal of this product will contribute to the effective usage of natural resources. For more information about where you can drop off your waste equipment for recycling, please contact your local city office, waste authority, approved WEEE scheme or your household waste disposal service. For more information regarding return and recycling of WEEE products, please visit www.canon-europe.com/environment. (EEA: Norway, Iceland and Liechtenstein)

■ Trademarks

- Canon and the Canon logo are registered trademarks of Canon Inc. in the United States and may also be trademarks or registered trademarks in other countries.
- Microsoft and Windows are registered trademarks of Microsoft Corporation in the United States and other countries.
- ISIS is a registered trademark of EMC Corporation in the United States.
- Intel and Pentium are registered trademarks of Intel Corporation.
- imageFORMULA is a trademark of CANON ELECTRONICS INC.
- Other product and company names herein may be the trademarks of their respective owners.

■ Copyright

Copyright 2016 by CANON ELECTRONICS INC. All rights reserved.

No part of this publication may be reproduced or transmitted in any form or by any means, electronic or mechanical, including photocopying and recording, or by any information storage or retrieval system without the prior written permission of CANON ELECTRONICS INC.

■ Reproduction Warning

This device is designed to be used in a legal manner, in accordance with all applicable laws, including, but not limited to, counterfeit and copyright laws, as well as laws pertaining to national security.

Any person(s) found to have reproduced any of the following materials (regardless of whether such reproduction was intentional or not) for the purpose of misrepresenting such material as the original may be prosecuted in accordance with the applicable laws and regulations.

- Paper money or bank notes (domestic and foreign)
- Postage stamps, revenue stamps, or other similar stamps
- Stock certificates, bond certificates, promissory notes, cheques, or other valuable certificates
- Passports, licenses, or other certificates or documents issued by government officials or agencies

This is not an exhaustive list.

Canon is not responsible for how this scanner is used by an individual.

Please note that certain intellectual property is protected by copyright law, and copyrighted items may not be reproduced without the express permission of the copyright holder except for personal or household use under limited circumstances.

■ Disclaimers

The information in this document is subject to change without notice.

CANON ELECTRONICS INC. MAKES NO WARRANTY OF ANY KIND WITH REGARD TO THIS MATERIAL, EITHER EXPRESS OR IMPLIED, EXCEPT AS PROVIDED HEREIN, INCLUDING WITHOUT LIMITATION, THEREOF, WARRANTIES AS TO MARKETABILITY, MERCHANTABILITY, FITNESS FOR A PARTICULAR PURPOSE OF USE OR NON-INFRINGEMENT. CANON ELECTRONICS INC. SHALL NOT BE LIABLE FOR ANY DIRECT, INCIDENTAL, OR CONSEQUENTIAL DAMAGES OF ANY NATURE, OR LOSSES OR EXPENSES RESULTING FROM THE USE OF THIS MATERIAL.

CANON ELECTRONICS INC. IS NOT LIABLE FOR THE STORAGE AND HANDLING OF DOCUMENTS SCANNED WITH THIS PRODUCT, OR THE STORAGE AND HANDLING OF RESULTING SCANNED IMAGE DATA.

IF YOU INTEND TO DISCARD THE ORIGINALS OF SCANNED DOCUMENTS, YOU THE CUSTOMER ARE RESPONSIBLE FOR INSPECTING THE SCANNED IMAGES AND VERIFYING THAT DATA IS INTACT.

THE MAXIMUM LIABILITY OF CANON ELECTRONICS INC. UNDER THIS WARRANTY IS LIMITED TO THE PURCHASE PRICE OF THE PRODUCT COVERED BY THE WARRANTY.

■ **FCC REGULATIONS (For 120 V model)**

Document Scanner, Model M182010

This device complies with Part 15 of the FCC Rules. Operation is subject to the following two conditions: (1) This device may not cause harmful interference, and (2) this device must accept any interference received, including interference that may cause undesired operation.

Note: This equipment has been tested and found to comply with the limits for a Class B digital device, pursuant to Part 15 of the FCC Rules. These limits are designed to provide reasonable protection against harmful interference in a residential installation. This equipment generates, uses, and can radiate radio frequency energy and, if not installed and used in accordance with the instructions, may cause harmful interference to radio communications. However, there is no guarantee that interference will not occur in a particular installation. If this equipment does cause harmful interference to radio or television reception, which can be determined by turning the equipment OFF and ON, the user is encouraged to try to correct the interference by one or more of the following measures:

- Reorient or relocate the receiving antenna.
- Increase the separation between the equipment and receiver.
- Connect the equipment into an outlet on a circuit different from that to which the receiver is connected.
- Consult the dealer or an experienced radio/TV technician for help.

Use of shielded cable is required to comply with Class B limits in Subpart B of Part 15 of FCC Rules.

Do not make any changes or modifications to the equipment unless otherwise specified in the manual. If such changes or modifications should be made, you could be required to stop operation of the equipment.

Canon U.S.A. Inc.
One Canon Park, Melville, NY 11747, U.S.A.
Tel. No. (800)652-2666

■ **RADIO INTERFERENCE REGULATIONS (For 120 V models)**

This digital apparatus does not exceed the Class B limits for radio noise emissions from digital apparatus as set out in the interference-causing equipment standard entitled "Digital Apparatus", ICES-003 of the Industry Canada.

■ **RÈGLEMENT SUR LE BROUILLAGE RADIOÉLECTRIQUE (For 120 V models)**

Cet appareil numérique respecte les limites de bruits radioélectriques applicables aux appareils numériques de Classe B prescrites dans la norme sur le matériel brouilleur: "Appareils Numériques", NMB-003 édictée par l'Industrie Canada.

■ **MODEL NAMES**

The following names may be provided for the safety regulations in each sales region of the document scanner.

Model Flatbed Scanner Unit 102 is identical to model M182010.
Model Flatbed Scanner Unit 102 is the sales name of model M182010.

Table of Contents

Setup Guide	5
Preface	7
Symbols Used in This Manual.....	7
Important Safety Instructions	8
Installation Location	8
AC Adapter.....	8
Moving the Flatbed.....	9
Handling	9
Disposal	10
When Sending the Flatbed for Repairs	10
Features	10
Names and Functions of Parts	11
Documents	12
Placing Documents	12
Scanning Methods	13
Feeder Scanning.....	13
Limitations	13
Supported Functions	13
Scanning with CapturePerfect	15
Other Methods for Scanning	19
Changing the Feeding Option for Scanning	19
Using Two Scanners	21
Troubleshooting	22
Common Problems and Solutions.....	22
Appendix	23
Routine Cleaning.....	23
Auto Power OFF Setting	24
Specifications	25
External Dimensions Diagram	26

Setup Guide

Please read first.

STEP 1 Checking the Accessories

If any of the items listed below are missing or damaged, contact your local authorized Canon dealer or service representative.

Flatbed Scanner Unit 102

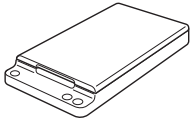

USB cable (Length: 70.9" (1.8 m))



AC Adapter/Power Cord* (Connected length: 102" (2.6 m))
* The shape of the power plug varies by country and region.



Manuals and software

- Setup Guide (This document)
- Registration Card (U.S.A and Canada only)
- Warranty Card (U.S.A and Canada only)
- Setup Disc

- Items included in this manual are subject to change without notice.
- You must keep the machine's packaging and packing materials for storing or transporting the machine.

STEP 2 Removing the Protective Material

Remove the orange adhesives and protective material (indicated by ▼ below) from the flatbed.

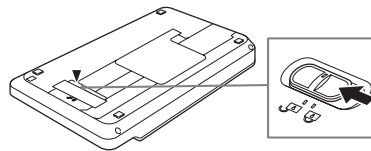
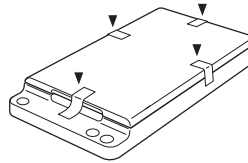

Set the lock switch at the bottom of the flatbed to the  position to release the scanning unit.

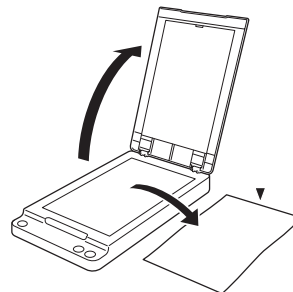

STEP 3 Installing the Software

- Log on to Windows as an Administrator.
- Close all other applications.
- Install the driver for the Canon document scanner beforehand.
- Do not connect the flatbed to the computer. If you connected the flatbed to the computer and turned it ON, click [Cancel] in the screen that appears, and turn OFF the flatbed.

1 Insert the setup disc into the computer.

- If the setup menu does not start up automatically, execute setup.exe from the setup disc.
- If the [User Account Control] screen appears, click [Yes] (or [Allow]).

2 Click [Typical Installation], and follow the instructions on the screen to complete installation.



3 Click [Exit] to close the setup menu.

STEP 4 Connecting to the Computer and Power Supply

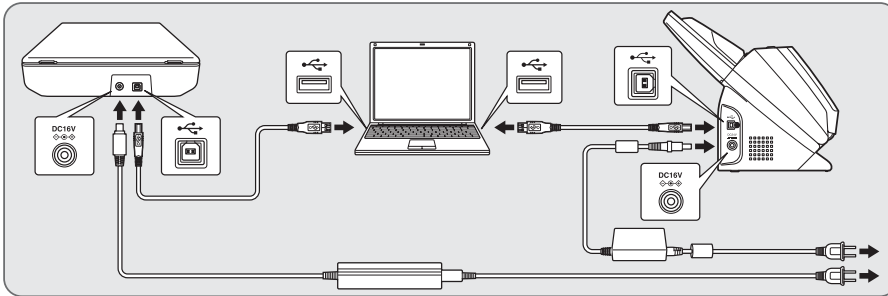

- Use the USB cables supplied with each scanner.
- Do not connect scanners other than the Canon document scanner that will be used in conjunction with the flatbed to the computer, regardless of whether they are compatible with the flatbed. If you do so, the flatbed or the Canon document scanner may not operate properly.

STEP 5 Turning the Power ON

Turn ON the flatbed first, and then turn ON the Canon document scanner.

1

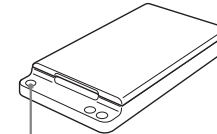

Power button

2

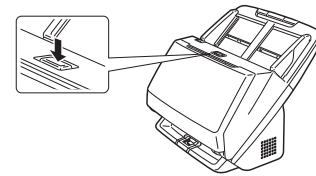

This completes the setup.

Preface

Thank you for purchasing the Canon imageFORMULA Flatbed Scanner Unit 102. Please read this manual thoroughly before using the scanner to familiarize yourself with its capabilities, and to make the most of its many functions. After reading this manual, store it in a safe place for future reference.

NOTE

An electronic version of this manual is installed to the following location as a PDF (Portable Document Format) file during software installation from the setup disc.

Windows 7/Vista

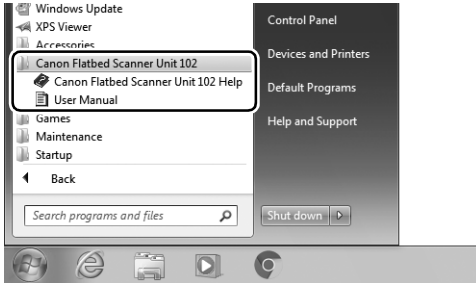

Windows 8.1

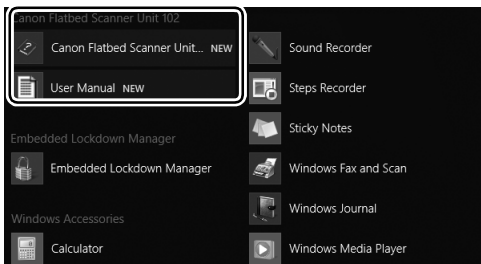

Windows 10

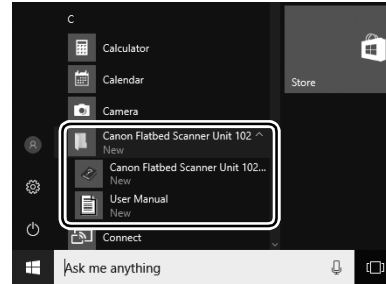

Symbols Used in This Manual

The following symbols are used in this manual to explain procedures, restrictions, handling precautions, and instructions that should be observed for safety.

WARNING

Indicates a warning concerning operations that may lead to death or injury to persons if not performed correctly. To use the machine safely, always pay attention to these warnings.

CAUTION

Indicates a caution concerning operations that may lead to injury to persons, or damage to property if not performed correctly. To use the machine safely, always pay attention to these cautions.

IMPORTANT

Indicates operational requirements and restrictions. Be sure to read these items carefully to operate the machine correctly, and avoid damage to the machine.

NOTE

Indicates a clarification of an operation, or contains additional explanations for a procedure. Reading these notes is highly recommended.

Important Safety Instructions

To ensure the safe operation of this flatbed, make sure to read the safety warnings and precautions described below.

Installation Location

The performance of this flatbed is affected by the environment in which it is installed. Make sure that the location where the flatbed is installed meets the following environmental requirements.

- Provide adequate space around the flatbed for operation, maintenance, and ventilation.

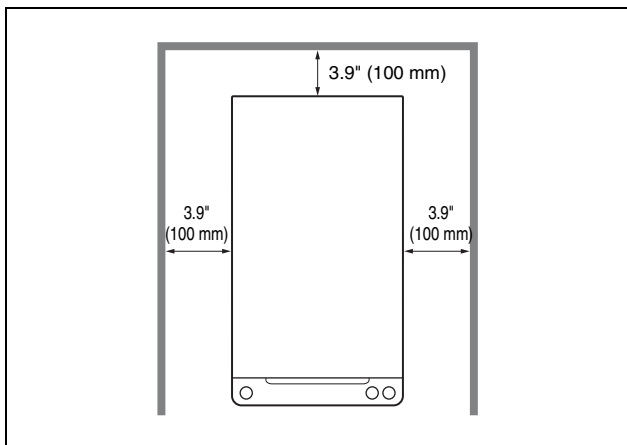

- Avoid installing the flatbed in direct sunlight. If this is unavoidable, use curtains to shade the flatbed.
- Avoid locations with excessive dust. Dust can have negative effects on the inner parts of the flatbed.
- Avoid warm or humid locations, such as in the vicinity of a water faucet, water heater, or humidifier. Avoid locations where ammonia gas is emitted. Avoid locations near volatile or flammable chemicals, such as alcohol or paint thinner.
- Avoid locations that are subject to vibration.

- Avoid exposing the flatbed to rapid changes in temperature. If the room in which the flatbed is installed is cold but rapidly heated, water droplets (condensation) may form inside the flatbed. This may result in a noticeable degradation in scanning quality. The following conditions are recommended for optimal scanning quality:
Room temperature: 50°F to 90.5°F (10°C to 32.5°C)
Humidity: 20% to 80% RH
- Avoid installing the flatbed near equipment that generates a magnetic field (e.g., speakers, televisions, or radios.)

AC Adapter

- Connect the AC adapter only to a power outlet of the rated voltage and power supply frequency (120 V, 60 Hz or 220-240 V, 50/60 Hz depending on your region).
- Do not connect other electrical equipment to the same power outlet to which the flatbed is connected. Also, if you use an extension cord, make sure that the extension cord is rated for the current requirements of the flatbed.
- Never disassemble or modify the AC adapter, as this is dangerous.
- The power cord may become damaged if it is often stepped on or if heavy objects are placed on it. Continued use of a damaged power cord and AC adapter may lead to an accident, such as a fire or electrical shock.
- Do not use the power cord while it is coiled.
- Do not pull directly on the power cord. When disconnecting the power cord, grasp the power plug and remove it from the power outlet.
- Keep the area around the power cord clear of objects so that the power cord can be disconnected easily in an emergency.
- Do not use an AC adapter other than the one provided with the flatbed. Do not use the AC adapter provided with the flatbed with other products.
- If you have any questions regarding the power supply, contact your local authorized Canon dealer or service representative for further information.

Moving the Flatbed

- If you move the flatbed, make sure to set the lock switch at the bottom of the flatbed to the  position to lock the scanning unit into place. Make sure to carry the flatbed with both hands so as not to drop it. The flatbed weighs approximately 5.5 lb. (2.5 kg).

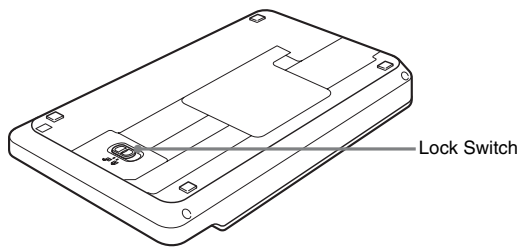

- Before using the flatbed, set the lock switch at the bottom of the flatbed to the  position to release the scanning unit.
- Make sure to disconnect the interface cable and AC adapter before you move the flatbed. If the flatbed is transported with these items connected, the plugs and connectors may be damaged, or cause the flatbed to fall and result in personal injury or damage to the flatbed.

Handling

WARNING

- Never use alcohol, benzene, paint thinner, aerosol sprays, or any other flammable substance near the flatbed.
- Do not cut, damage, or modify the power cord. Do not place heavy objects on the power cord, and do not pull or excessively bend the power cord.
- Never connect the power cord when your hands are wet.
- Do not connect the flatbed to a multiplug power strip.
- Do not knot or coil the power cord, as this may result in a fire or electric shock. When connecting the power cord, make sure that the power plug is securely and completely inserted into the power outlet.
- Do not use a power cord or AC adapter other than the ones provided with this flatbed. Do not use the supplied power cord with other products.
- Do not take the flatbed apart or modify it.

- Never disassemble or modify the AC adapter, as this is dangerous.
- Do not use flammable sprays near the flatbed.
- When cleaning the flatbed, turn the power switch OFF and disconnect the power cord from the power supply.
- Clean the flatbed using a slightly dampened cloth that has been well wrung out. Never use alcohol, benzene, paint thinner, or any other flammable substances.
- Disconnect the power cord from the power outlet regularly, and clean the area around the base of the power plug's metal pins and the power outlet with a dry cloth to ensure that all dust and grime is removed. If the power cord is connected for a long period of time in a damp, dusty, or smoky location, dust can build up around the power plug and become damp. This may cause a short circuit and result in a fire.
- If the flatbed makes strange noises, or gives off smoke, heat or strange odors, or the flatbed does not function or other abnormalities occur when you use the flatbed, immediately turn the power switch OFF and disconnect the power plug from the power outlet. Then, contact your local authorized Canon dealer or service representative for further information.
- Do not drop the flatbed, or subject it to impact or strong shock. Should the flatbed ever become damaged, immediately turn the power switch OFF, and disconnect the power plug from the power outlet. Then, contact your local authorized Canon dealer or service representative for further information.
- Before moving the flatbed, make sure to turn the power switch OFF, disconnect the power plug from the power outlet, and set the lock switch at the bottom of the flatbed to the  position to lock the scanning unit into place.

CAUTION

- Do not install the flatbed on a surface that is unstable, tilted, or subject to excessive vibrations. Doing so may cause the flatbed to fall, resulting in personal injury or damage to the flatbed.
- Never place small metal objects, such as staples, paper clips, or jewelry on the flatbed. These items may fall into the flatbed, and cause a fire or electric shock. If such objects ever fall inside the flatbed, immediately turn the power switch OFF, and disconnect the power plug from the power outlet. Then, contact your local authorized Canon dealer or service representative to have the unit serviced.
- Do not install the flatbed in a humid or dusty location. Doing so may cause a fire or electric shock.

- Do not place objects on the flatbed. The objects may fall over or off of the flatbed, resulting in personal injury.
- Connect the AC adapter only to a power outlet of the rated voltage and power supply frequency (120 V, 60 Hz or 220-240 V, 50/60 Hz depending on your region).
- When unplugging the power cord, grasp it firmly by its power plug. Do not pull directly on the power cord, as this may damage or expose the cord's internal wiring, resulting in a fire or electric shock.
- Leave sufficient space around the power plug so that it can be disconnected easily. If objects are placed around the power plug, you will be unable to disconnect it in an emergency.
- Do not allow water or flammable substances (alcohol, paint thinner, benzene, etc.) to spill onto the flatbed, as this may result in a fire or electric shock.
- Also, turn OFF the power switch, and disconnect the power cord from the power outlet for safety when the machine will not be used for an extended period of time, such as during consecutive holidays.
- Open and close the document cover gently. Failure to do so may result in a malfunction or personal injury.
- Be careful when closing the document cover to avoid pinching your hands. Failure to do so may result in personal injury.
- Do not press down hard on the document cover. Doing so may result in damage to the glass, a malfunction, or personal injury.
- Never place any object other than documents to be scanned onto the scanning glass. Doing so may result in a malfunction or personal injury.
- When using the flatbed in cold temperatures, wait a few moments after turning the power switch ON. Failure to do so may result in a condensation error.

Disposal

When disposing the flatbed or AC adapter, make sure to follow the local ordinances and laws or consult with your local authorized Canon dealer or service representative.

When Sending the Flatbed for Repairs

If you need to send the flatbed out for repairs, use the packing box in which it came. Make sure to set the lock switch at the bottom of the flatbed to the  position to lock the scanning unit into place, and firmly secure the flatbed with packaging material when you place it in the packing box.

Features

The Flatbed Scanner Unit 102 is intended to be used in combination with the Canon document scanners. The flatbed cannot operate as a stand-alone unit.

The main features of the flatbed are described below.

● Wide-range document support

Connect the flatbed scanner and a Canon document scanner to a computer to enable flatbed scanning. The flatbed allows you to scan thin document sheets, magazines, and a variety of other documents that cannot be scanned using a feeder.

● High Image Quality

The flatbed enables high-quality 600 dpi scanning in 24-bit color, grayscale, and black and white scanning modes.

● Seamless Dual-Scanner Operation

Combine the scanned images from two scanners to create a single image file.



NOTE

The flatbed does not support all of the scanning options available on the connected Canon document scanner.

Names and Functions of Parts

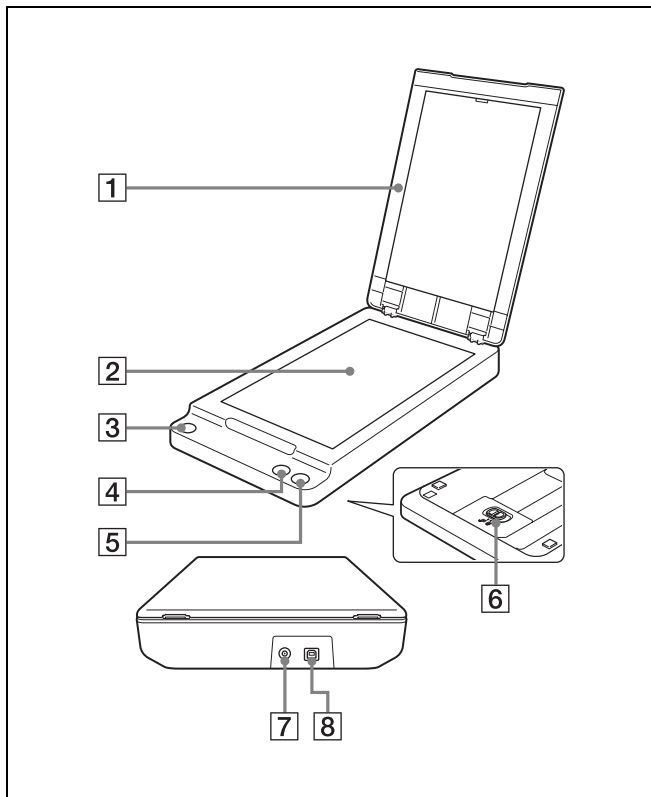

1 Document Cover

Close this to keep documents in place while scanning.

2 Scanning Glass

3 Power Button

Press this to turn ON the flatbed. The power button lights when the flatbed is turned ON.

To turn the flatbed OFF, press and hold the power button until it turns OFF.



NOTE

The auto power OFF setting, which automatically turns the flatbed OFF if it is not operated for 4 hours, is enabled under default conditions.

For details on disabling this setting, "Auto Power OFF Setting" (p. 24).

4 Start Button

Press this button to start scanning the document placed on the scanning glass.

5 Stop Button

Press this button to stop scan procedures in progress.

6 Lock Switch

Use this to lock the internal scanning unit into place.

7 Power Connector

Connect the provided AC adapter here.

8 USB Connector (Type B)

Use this connector to connect the flatbed to a computer.

Documents

The flatbed can scan documents up to 8.5" (216 mm) in width and 14.0" (356 mm) in length.

Placing Documents

Open the document cover, and place the document on the scanning glass, as shown below, with the scanning side facing down. Make sure to align the bottom right corner of the scanning side with the bottom left corner of the scanning glass.

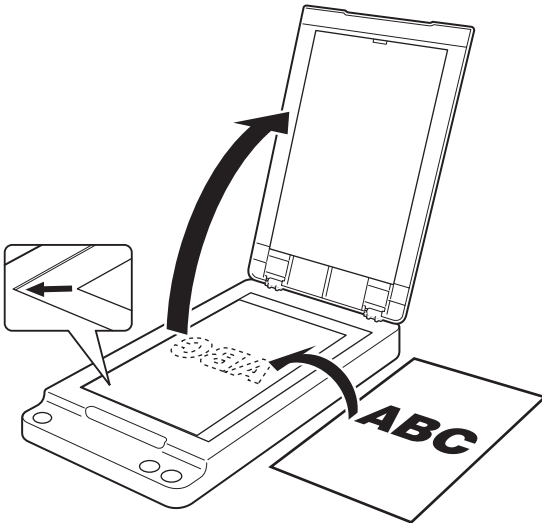

- Make sure to straighten wrinkled or curled documents before placing them on the flatbed, and gently press down on the document cover while scanning is in progress.

! IMPORTANT

- Do not place objects other than the document to be scanned onto the scanning glass. Doing so may result in a malfunction or personal injury.
- Open and close the document cover gently. Excessive force may result in damage to the cover or breaking the scanning glass and personal injury.
- You cannot scan film.

Scanning Methods

When the flatbed scanner unit is connected to a scanner and computer, you can select one of the following methods to scan documents, based on the document type and intended purpose.

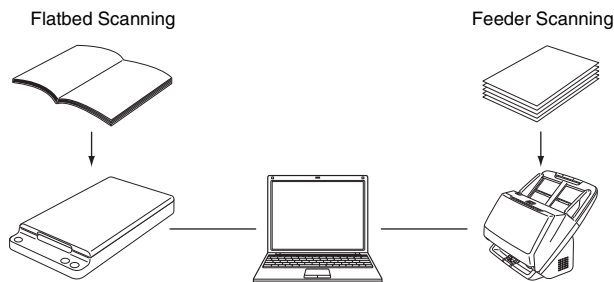

Flatbed Scanning

You can use the flatbed to scan documents one sheet at a time, single page documents, or documents that cannot be scanned using the feeder.

Feeder Scanning

Use the feeder on a Canon document scanner connected to the computer to perform operations such as multipage document scanning. In such cases, the operations on the connected Canon document scanner are the same as those during stand-alone use. For details on feeder scanning, refer to the *User Manual* of the connected Canon document scanner.

Limitations

- To use the flatbed, you must install the software included on the provided setup disc. The software that operates the connected Canon document scanner (ISIS/TWAIN driver) must also be installed.
- If WIA driver is installed, the flatbed can operate as a stand-alone unit without a Canon document scanner connected. In that case, however, there are limitations on the functions available comparing with the usual scanning using the ISIS/TWAIN driver.
- Both the flatbed and the connected Canon document scanner must be turned ON to scan using the flatbed. If the flatbed is turned ON but the

Canon document scanner is turned OFF, you cannot scan documents using the flatbed. However, you can scan documents using the Canon document scanner while it is turned ON, even if the flatbed is turned OFF.

- When the conditions for scanning require a large amount of the computer's memory, scanning may not be possible if the memory is insufficient. If a memory error appears during scanning, exit the application and change the scanning conditions before attempting to scan again.

Supported Functions

To scan using the functions supported by the flatbed, the connected Canon document scanner must also support the functions used.

Functions	Use on the flatbed	Functions	Use on the flatbed
Advanced Text Enhancement	No	Prevent Bleed Through / Remove Background	Yes
Advanced Text Enhancement II	Yes	Remove shadow	No
Hi-Speed Text Enhancement	No	Border Removal	Yes
Auto Color Detection	Yes	Erase Dot	Yes
Color/gray/binary detection	Yes	Text Orientation Recognition	Yes
Color/gray detection	Yes	Erase Notch	Yes
Automatic Size Detection	Yes	Punch Hole Removal	Yes
Area specification	Yes	Apply corrections suitable for photographs	No
Margin	No	Double Feed Detection	No
Auto resolution detection	Yes	Automatic Feeding	No
Two Sided Scanning	No	Manual Feeding	No
Skip Blank Page	No	Panel-Feeding	Yes
Folio	No	Thin Paper Mode	No
Speed priority	No	Non Separation Feeding Mode	No
Skew Detection	No	Verify Count	No
Deskew	Yes	Staple Detection	No
Reverse side	No	Document Orientation	Yes
Brightness Auto	No	Batch Separation	No
Gamma Correction	Yes	Patchcode	No
Edge emphasis	Yes	Rapid recovery system	No
Color drop-out / color enhance (red/green/blue)	Yes	JPEG Transfer	No
Color drop-out / color enhance (red/green/blue)	Yes	Prescan	No
Color Elimination	No	MultiStream	Yes

Functions	Use on the flatbed	Functions	Use on the flatbed
Custom color drop-out	No	Back-side settings (when MultiStream is enabled)	No
Custom color Enhance	No	Barcode	Yes
Moire Reduction	Yes	2D code	Yes
Character Emphasis	Yes	Imprinter	No
Background smoothing	Yes	Addon	No

(Yes: Supported, No: Not supported)

Scanning with CapturePerfect

You can use the CapturePerfect software provided with the connected Canon document scanner to specify the scanning conditions and saving options before scanning.

The following describes how to scan documents with CapturePerfect using the [Scan Batch to File] setting. When you use this scanning method, documents that are scanned one sheet at a time on the flatbed are saved to the same image file.

This section describes the scanning procedure in CapturePerfect 3.1. The same procedure can be used in CapturePerfect 3.0.

NOTE

For details on other scanning methods, refer to the *CapturePerfect Operation Guide*.

- 1 From the Windows Taskbar, click [Start] and select [All Programs], [CapturePerfect 3.1], and [CapturePerfect 3.1].**

CapturePerfect starts.

- 2 Select [Select Scanner] from the [Scan] menu.**

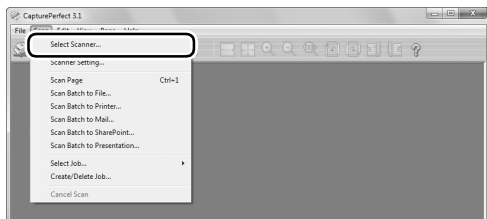

The [Select Scanner] dialog box appears.

- 3 Select the name of the Canon document scanner you are using which should be followed by "w/FSU102", and click the [Settings] button.**

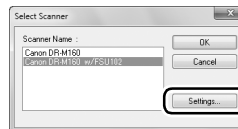

The [Configure Device Settings] dialog box appears.

IMPORTANT

If only the scanner name appears, try reinstalling the software included on the setup disc provided with the flatbed.

- 4 Click [OK] to finish scanner selection.**

- 5 Select [Scan Batch to File] from the [Scan] menu.**

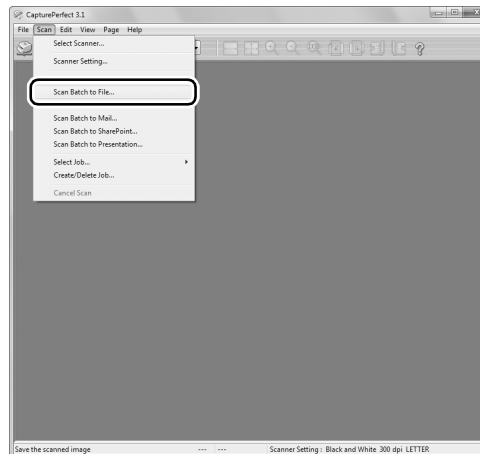

The [Scan Batch to File] dialog box appears.

6 Click [Scanner Setting], and configure the scanner settings.

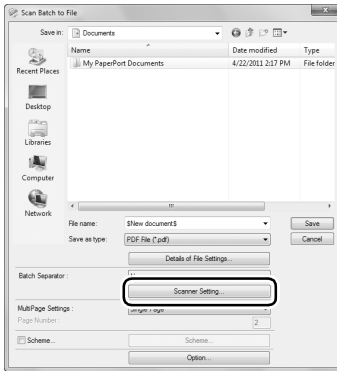

The properties dialog box for the scanner driver appears.

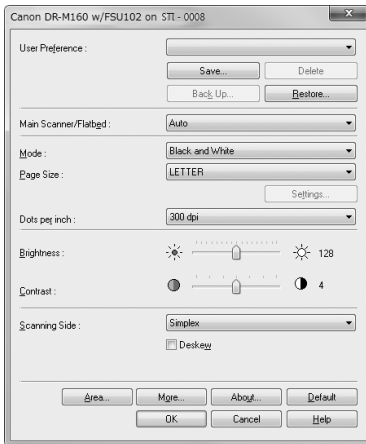

7 Configure the [Main Scanner/Flatbed] setting.

Select [Flatbed] if the document is placed on the flatbed, and select [Main Scanner] if the document is placed in the Canon document scanner. If you select [Auto], any documents placed in the feeder will be scanned. If there are no documents in the feeder, scanning is performed on the flatbed.

8 Configure the Canon document scanner's settings if necessary.

Click the [More] button to open the settings dialog box for the Canon document scanner. When you finish configuring settings, click [OK] to close the dialog box.

For details on each setting, refer to the Help.

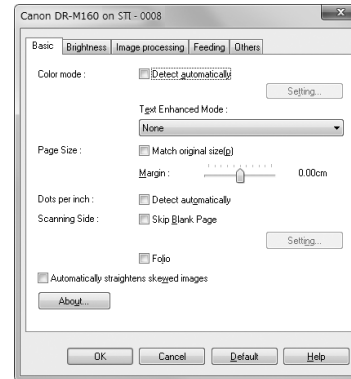

9 Configure the scanning conditions.

For details on settings, p. 17.

10 Specify the file name and format for the image file to be saved.

For details on other settings in the [Scan Batch to File Setting] dialog box, refer to the *CapturePerfect Operation Guide*.

11 Place the documents to be scanned, and click [Save] to start scanning.

! IMPORTANT

- The method for placing documents differs, depending on the [Feeding Option] setting. For details, p. 19.
- Do not move the document placed on the scanning glass while the power indicator is flashing and scanning is in progress.

- 12** When the [Continue Scanning] dialog box appears, and click [Continue Scanning] or [Cancel Scan].

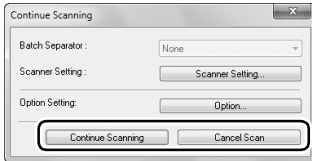

- 13** When scanning is complete, select [Exit] from the [File] menu to exit CapturePerfect.

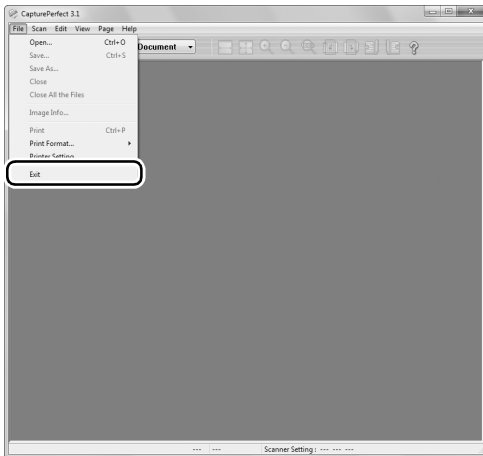

Scanner Settings

When you open the settings dialog box for your scanner while the flatbed is connected, you can configure scan conditions with the following settings.



[User Preference]

Enter a name and click [Save]. You can recall the name and its configurations in the settings dialog box, whenever necessary.

[Main Scanner/Flatbed]

Select [Flatbed] to scan the document placed on the flatbed. Select [Main Scanner] to scan documents placed in the feeder of the connected Canon document scanner.

If you select [Auto], any documents placed in the feeder will be scanned. If there are no documents in the feeder, scanning is performed on the flatbed.

For details, "Using Two Scanners" (p. 21).

[Mode]

Select the scanning mode.

[Page Size]

Select the page size of the document to be scanned. If you select [Match original size], the document size is detected automatically. The [Settings] button is enabled in such cases, and by clicking the button and displaying the dialog box, you can configure the size detection area (legal, A4, or A5R area) according to the document to be scanned.

[Dots per inch]

Specify the scanning resolution.

[Brightness]

Adjust the brightness of scanned images.

[Contrast]

Adjust the contrast of scanned images.

[Scanning Side]

When scanning documents placed in the feeder of the connected Canon document scanner, select which sides of a document to scan.

[Automatically straightens skewed images]

Click to ensure that if a document is scanned at an angle, the slant is detected and straightened out in the scanned image.

[Area]

Click this to display a dialog box for specifying the area of the document to scan.

[More]

Click this to display the settings dialog box for the connected Canon document scanner, and configure advanced scan conditions. For details on settings, refer to the *Help for the ISIS/TWAIN driver*.

[Default]

Return all configurations in the settings dialog box to their default values.

Other Methods for Scanning

This section describes the various scanning options.

Changing the Feeding Option for Scanning

Changing the feeding option setting in the scanner settings dialog box can be helpful when scanning multipage documents.

The following three feeding options are available:

● [Standard Feeding]

This is the standard feeding method. The scanning operation ends when the documents placed in either scanner finish scanning.

● [Panel-Feeding]

When the documents placed in either scanner finish scanning, the scanner enters a standby state and waits for additional documents to be placed. When you place additional documents and press the Start button, scanning continues.

● Automatic Feeding

When additional documents are placed after a document finishes feeding, the scanner automatically detects these documents and continues scanning.

This feeding option can only be selected when [Main Scanner/Flatbed] is set to [Main Scanner].

Configuring the Feeding Option

This section describes how to set [Feeding Option] to [Panel-Feeding].

1 Open the scanner settings dialog box from your application.

When using CapturePerfect, for example, select [Scanner Setting] from the [Scan] menu. For details on how to open the settings dialog box from other applications, refer to the operation manual of the application.

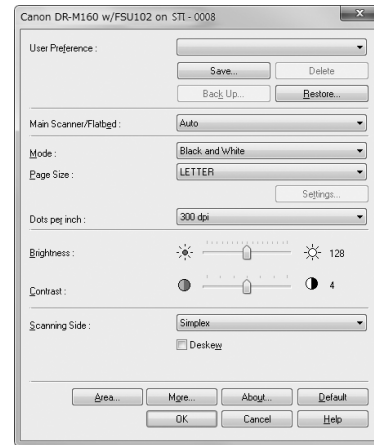

2 Configure the [Main Scanner/Flatbed] setting.

If the document is placed in the feeder of the connected Canon document scanner, select [Main Scanner]. If you plan to switch between using the feeder and flatbed for scanning, select [Auto].

3 Click the [More] button to open the settings dialog box for the Canon document scanner.

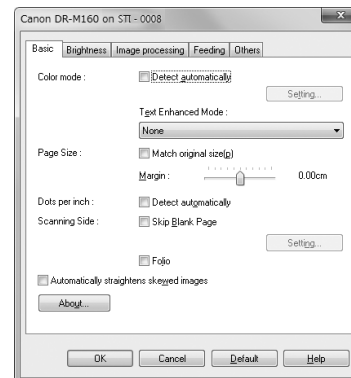

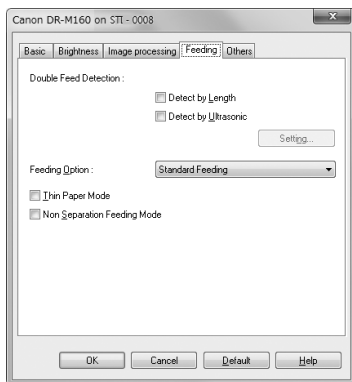
4 Click the [Feeding] tab.

5 Set [Feeding Option] to [Panel-Feeding].

6 Click [OK] to close the settings screen.

7 Click [OK] to close the scanner settings dialog box.

8 Place the document in the scanner, and start the scan procedure from the application.

9 Press the start button on the scanner in which the document is placed.

If the document is placed in the Canon document scanner, pressing the start button on the scanner will start the scan procedure.

If the document is placed on the flatbed, pressing the start button on the flatbed will start the scan procedure.

When the document finishes scanning, the scanner waits for the next document to be placed.

10 Place the next document to be scanned.

If you selected [Auto] for [Main Scanner/Flatbed] in step 2, you can place the document in either the feeder or the flatbed to continue scanning.

11 Repeat steps 9 and 10 until all documents are scanned.

12 Press the stop button on the scanner when all documents have been scanned.

This completes the scan procedure.

 **NOTE**

Depending on the application you are using and whether the flatbed is connected, scanner operations when scanning with the [Feeding Option] set to [Panel-Feeding] may differ as follows.

When scanning with only a Canon document scanner	When scanning with the flatbed connected
When you press the stop button on the scanner, a dialog box asking whether you want to continue scanning appears.	You must press the stop button on the scanner twice to display the dialog box that asks whether you want to continue scanning.
When you select the option to continue scanning in the above dialog box, the driver settings screen appears automatically.	Selecting the option to continue scanning will not automatically display the driver settings screen. You must press the start button on the scanner.

Using Two Scanners

Setting [Main Scanner/Flatbed] to [Auto] in the scanner settings dialog box makes it easy to scan certain types of documents with one scanner or the other, or scan using a combination both scanners.

Example 1: Scan using the appropriate scanner for each scan operation

By configuring the following settings, you can scan documents suited for the flatbed (e.g., a single page of a book) or documents suited for the connected Canon document scanner (e.g., one or more document sheets), without having to specify the scanner.

[Main Scanner/Flatbed]: [Auto]
[Feeding Option]: [Standard]

Example 2: Scan different document types to a single image file

By configuring the following settings, you can scan multiple documents of different types (e.g., multiple pages of a book and multiple document sheets) to a single file.

[Main Scanner/Flatbed]: [Auto]
[Feeding Option]: [Panel-Feeding]

For example, perform the following to scan a multipage application form and a passport.

- (1) Start the scan procedure from the application.
- (2) Place the application form in the Canon document scanner, and press the start button on the document scanner.
- (3) When the application form is scanned, place the passport on the flatbed, and press the start button on the flatbed.
- (4) When you are finished scanning, press the stop button on the flatbed or document scanner.

Troubleshooting

Common Problems and Solutions

This section provides recommended solutions to common problems. If you have a problem that is not solved by the following, contact your local authorized Canon dealer.

Problem 1 The flatbed will not turn ON.

Solution Confirm that the AC adapter is plugged firmly into a power outlet.

Problem 2 The flatbed is not recognized.

Solution

- (1) Confirm that the flatbed is properly connected to the computer with a USB cable.
- (2) Confirm that the scanners (both the flatbed and the Canon document scanner) are turned ON. If the flatbed is turned ON but the Canon document scanner is turned OFF, the flatbed will not operate. See Problem 1 if the scanner does not turn ON.
- (3) The computer's USB interface may not support the flatbed. The flatbed cannot be guaranteed to work with all USB interfaces.
- (4) Confirm that the supplied USB cable is used to connect the flatbed to the computer. The flatbed cannot be guaranteed to work with all available USB cables.
- (5) If the flatbed is connected to the computer via a USB hub, try removing the hub and connecting the flatbed directly to the computer.



Problem 3 Dirt appears in scanned images.

Solution Clean the scanning glass. If a sticky substance such as glue or correction fluid is found, carefully wipe with just enough pressure to clean the area where the lines appear. If the problem cannot be solved by cleaning, the internal glass may be scratched. In this case, contact your local authorized Canon dealer.

Problem 4 Text is not enhanced in scanned images, even though [Text Enhanced Mode] is specified.

Solution This flatbed only supports Advanced Text Enhancement II. When you open the Canon document scanner's ISIS/TWAIN driver settings dialog box from the flatbed's ISIS/TWAIN driver settings dialog box, you can specify text enhancement modes other than Advanced Text Enhancement II. However, Advanced Text Enhancement II will always be used when scanning from the flatbed. As a result, the text may not appear enhanced depending on the document that was scanned. To scan using the text enhancement mode that you specified, place the document in the document scanner and scan.

Problem 5 The scanner is recognized by the computer, but scanning does not start.

Solution Check the position of the lock switch at the bottom of the flatbed (p. 9). Even if the flatbed is turned ON, scanning will not be possible if the lock switch at the bottom of the flatbed is set to the  position. Set the lock switch to the  position, and press the power button to start scanning.

Problem 6 Scanning is not performed using the registered user preference settings.

Solution User preferences in which feeding option, skip blank page, continuous scanning, or prescan is enabled may not be recalled properly by some applications. When using such user preferences, make sure to open the driver settings dialog box and verify that the settings are enabled before you begin scanning.

Problem 7 The image rotation setting is enabled, but images are not rotated (or the edges are cropped).

Solution When the scanning resolution is set to a high value and image rotation is set to 90 or 270 degrees, the entire document may not be scanned properly. Set the image rotation to 0 or 180 degrees or set a lower resolution, and try scanning again.

Appendix

Routine Cleaning

Clean the flatbed on a regular basis to maintain scanning performance.

WARNING

For safety, always turn the power switch OFF and disconnect the power cord from the power outlet before cleaning the flatbed. Do not use spray-type cleaners to clean the flatbed. Precision mechanisms may get wet and malfunction. Never use paint thinner, alcohol, or other solvents to clean the flatbed. Doing so may deform, discolor, or dissolve surfaces, or result in a fire or electric shock.

Cleaning the Flatbed

Use a cloth dampened with water and thoroughly wrung out to clean the outside of the flatbed, and use a clean dry cloth to wipe the flatbed dry.

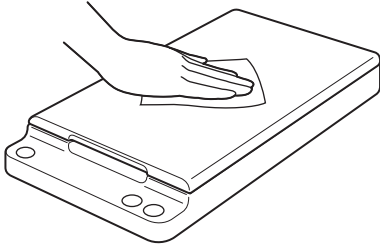

Cleaning the Scanning Glass and Pressure Board

If dirt appears in scanned images, or if scanned documents become dirty, the scanning glass and pressure board may be dirty. Be sure to clean them regularly.

- 1** Open the document cover gently, and use a clean, dry cloth to wipe the scanning glass and pressure board clean.

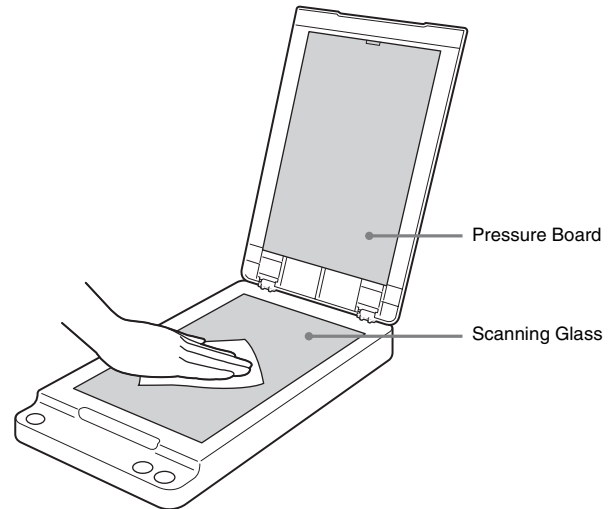

- 2** Close the document cover gently.

CAUTION

If you use excessive force when you close the document cover, it may result in damage to the glass, malfunction, or personal injury.

Auto Power OFF Setting

If scanning or any other operation is not performed on the flatbed for 4 hours, the flatbed will automatically turn OFF.

To disable this setting, perform the following.

1 Open the scanner settings dialog box from your application.

When using CapturePerfect, for example, select [Scanner Setting] from the [Scan] menu. For details on how to open the settings dialog box from other applications, refer to the operation manual of the application.

2 Click [About].

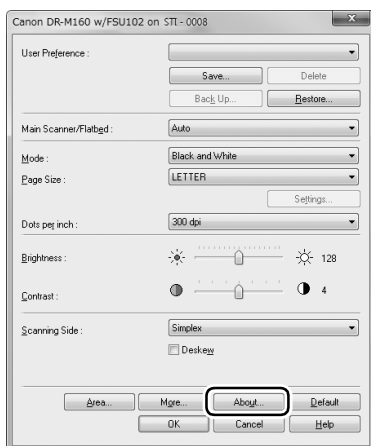

The version information dialog box appears.

3 Disable the [Turn off automatically after 4 hours] check box.

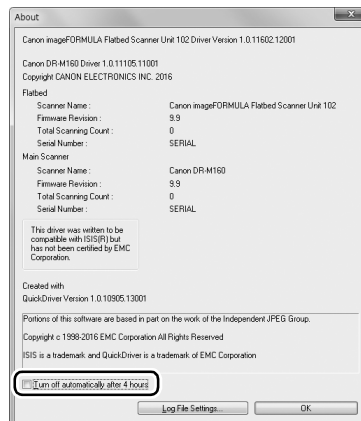

4 Click [OK] to close the version information dialog box.

Specifications

Main Unit

Type	Desktop flatbed		
Scanning Document Size	Width: 8.5" (216 mm)		
	Length: 14" (356 mm)		
Scanning Sensor	CIS		
Light Source	LED		
Scanning Side	Simplex		
Scanning Modes	Black and White, Error Diffusion, 256-level Grayscale, Advanced Text Enhancement II, 24-bit Color		
Scanning Resolution (Primary Scan Lines x Secondary Scan Lines)	100 x 100 dpi/150 x 150 dpi/200 x 200 dpi		
	240 x 240 dpi/300 x 300 dpi/400 x 400 dpi		
	600 x 600 dpi		
Scanning Speed (Conditions: Core 2 Duo 3.0GHz or faster CPU, 3 GB or more memory, LTR/A4 document size)	24-bit color	600 dpi	9.0 sec.
		300 dpi	3.5 sec.
	200 dpi	300 dpi	3.5 sec.
		150 dpi	3.5 sec.
		600 dpi	4.5 sec.
	Grayscale	300 dpi	3.0 sec.
		200 dpi	3.0 sec.
		150 dpi	3.0 sec.
Interface	Hi-Speed USB 2.0 (Type B x 1)		
External Dimensions	10.51" x 18.35" x 2.52" (W x D x H)		
	267 mm x 466 mm x 64 mm (W x D x H)		
Weight (without AC adapter)	Approximately 5.5 lb. (2.5 kg)		
Power Supply (using AC adapter)	DC 16 V, 0.4 A		
Power Consumption	Scanning: Maximum 7 W		
	In Sleep mode: Maximum 1.7 W		
	With power turned OFF: Maximum 0.5 W		
Noise	Not more than 59 dB		

Operating Environment

Temperature: 10°C to 32.5°C (50°F to 90.5°F)

Humidity: 20% to 80% RH

AC Adapter (100 to 240 V type)

Model Number	MG1-5042
Input	AC100 to 240V, 50/60 Hz, 0.57 to 0.32 A
Output	DC16V 1.6A
Weight	Approximately 0.44 lb (0.2 kg) (excluding power cord)

Recommended Operating Environment

The recommended operating environment other than the following is dependent on the connected scanner.

Operating System:

Microsoft Windows Vista with Service Pack 2 or later (32-bit and 64-bit editions)
Microsoft Windows 7 with Service Pack 1 (32-bit and 64-bit editions)
Microsoft Windows 8.1 (32-bit and 64-bit editions)
Microsoft Windows 10 (32-bit and 64-bit editions)
Microsoft Windows Server 2008 R2
Microsoft Windows Server 2012 R2
This is the environment as of December 2016.
For the latest software support information, go to the Products page on the Canon website.

External Dimensions Diagram

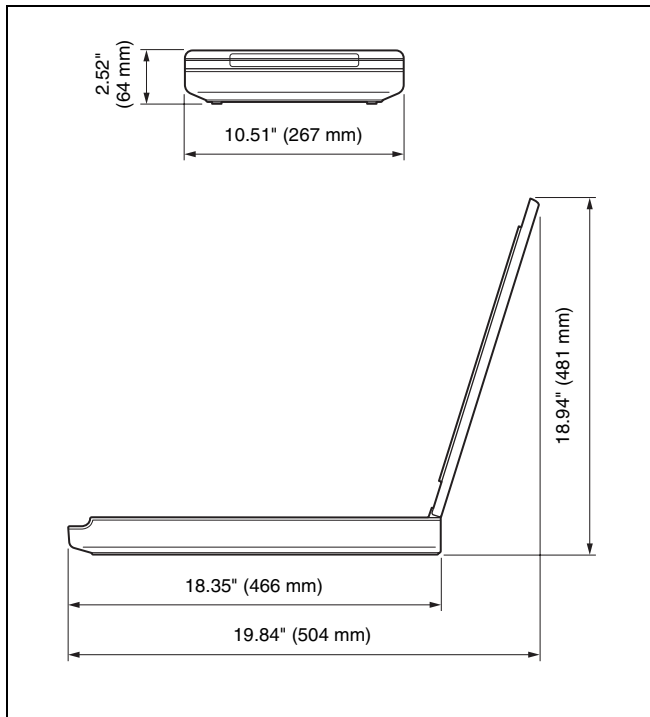



CANON ELECTRONICS INC.

3-5-10, Shibakoen, Minato-ku, Tokyo 105-0011, Japan

CANON U.S.A. INC.

ONE CANON PARK, MELVILLE, NY 11747, U.S.A.

CANON CANADA INC.

8000 Mississauga Road Brampton, Ontario L6Y 5Z7, CANADA

CANON EUROPA N.V.

BOVENKERKERWEG 59, 1185 XB AMSTELVEEN, THE NETHERLANDS

CANON AUSTRALIA PTY. LTD.

BUILDING A, THE PARK ESTATE, 5 TALAVERA ROAD, MACQUARIE PARK, NSW 2113, AUSTRALIA

CANON SINGAPORE PTE. LTD.

1 FUSIONPOLIS PLACE, #15-10, GALAXIS, SINGAPORE 138522

CANON INDIA PVT. LTD

7TH FLOOR, TOWER B DLF CYBER TERRACES DLF PHASE III GURGAON-122002 HARYANA, INDIA