

Canon

CANON INC.

30-2, Shimomaruko 3-chome, Ohta-ku
Tokyo 146-8501, Japan

CANON U.S.A., INC.

Digital Home and Personal Systems Division

2995 Redhill Avenue
Costa Mesa, CA 92626
1-800-OK-CANON
<http://www.ccsi.canon.com>

CANON CANADA INC.

6390 Dixie Road, Mississauga
Ontario L5T 1P7, Canada
1-800 OK CANON
<http://www.canon.ca>

CANON LATIN AMERICA, INC.

6505 Blue Lagoon Drive, Suite 325
Miami, Florida 33126, U.S.A.

CANON MEXICANA, S. de R.L. de C.V.

Anillo Periferico Sur No. 4124, Torre Zafiro (II) Colonia
Ex-Rancho de Anzaldo, Piso 5 y 6, Mexico D.F.
Tel. (525) 5490-2000

CANON PANAMA, S.A.

Apartado 7022, Panama 5
Rep. de Panama
Tel. (507) 279-8900

CANON CHILE, S.A.

Ave. Manquehue Norte #1337, Piso 3, Casilla 187-9,
Santiago, Chile
Tel. (562) 366-6600

CANON ARGENTINA, S.A.

Ave. Corrientes 420 (1043)
Buenos Aires, Argentina
Tel. (5411) 432-59800

CANON EUROPA N.V.

P.O. Box 2262 1180 EG Amstelveen,
The Netherlands

CANON (UK) LTD.

Woodhatch, Reigate
Surrey RH2 8BF, United Kingdom
For technical support, please contact Canon Helpdesk.

Helpdesk:
P.O. Box 431, Wallington, Surrey SM6 0XU
TEL: (08705) 143 723
FAX: (08705) 143 340
For sales enquiries: (0121) 666-6262

CANON COMMUNICATION & IMAGE FRANCE S.A.

102 Avenue du Général de Gaulle
92257 LA GARENNE COLOMBES CEDEX, France
Tel: 01.41.30.15.15 Fax: 01.41.30.15.05

CANON DEUTSCHLAND GmbH

Postfach 528, 47705 Krefeld, Germany
CANON- Hotline-Service
Customer Support: (0 21 51) 349-555
Info-Desk: (0 21 51) 349-566
Mailbox: (0 21 51) 349-577
Telefax: (0 21 51) 349-588

CANON ITALIA S.p.A

Palazzo L, Strada 6
20089 Milanofiori-Rozzano (MI), Italy
TEL: 02/8248. 1 FAX: 02/8248. 4604
Pronto Canon 02/8249. 2000
<http://www.canon.it>

CANON BENELUX NEDERLAND N.V.

Neptunusstraat 1, 2132 JA Hoofddorp
The Netherlands
Tel: 023-5 670 123 Fax: 023-5 670 124
Helpdesk: 023-5 681 681

CANON BENELUX BELGIUM N.V./S.A.

Bessenveldstraat 7, 1831 Diegem, Belgium
Tel: 02 7220411 Fax: 02 7213274
Helpdesk: 02 7220404

CANON GmbH

Zetschegasse 11, 1232 Wien, Austria

CANON (SCHWEIZ) A.G.

Industriestrasse 12, CH-8305 Dietlikon
Switzerland
Tel: (01) 835 61 61 Fax: (01) 835 68 60
Hotline: 157 30 20

CANON ESPAÑA S.A.

C/Joaquin Costa No 41, 28002
Madrid, Spain
Help Desk: 906.301255
Tel.: 91-5384500 Fax.: 91-4117780

CANON DANMARK

Vasekær 12, DK-2730 Herlev, Denmark
Hotline: 44 88 26 66
<http://www.canon.dk>

CANON NORGE AS

Hallagerbakken 110, Boks 33, Holmlia, 1210 Oslo 12,
Norway
Tlf: 2262 9321 FAX: 2262 0615

CANON SVENSKA AB

Gustav III:s Boulevard 26, S-169 88 Solna, Sweden
Tel 08-744 85 00
Fax 08-744 64 65
<http://www.canon.se>

CANON OY AB

Kornetintie, 3, 00380 Helsinki, Finland
Puhelin: 010 544 20
Helpdesk: 0600-0-22606
(maksu 14,80 mk/min)
Fax: 010 544 4571

CANON SINGAPORE PTE. LTD.

79 Anson Road #09-01/06
Singapore 079906
<http://www.canon-asia.com>

CANON MARKETING SERVICES PTE. LTD.

No. 1, Jalan Kilang Timor
#09-00 Pacific Tech Centre
Singapore 159303
Tel: 65-7998888, Fax: 65-2736786,
Hotline: 65-3342726
<http://www.canon.com.sg>

CANON MARKETING (MALAYSIA) SDN. BHD.

Block D, Peremba Square
Saujana Resort, Section U2, 40150 Shah Alam
Selangor Darul Ehsan, Malaysia
Tel: 603-7446000, Fax: 603-7446048,
Helpdesk: 603-7446008/9
Enquiry: print&scan@canon.com.my
<http://www.canon.com.my>

CANON MARKETING (THAILAND) CO. LTD.

179/34-45 Bangkok City Tower, 9th-10th Floor
South Sathorn Road, Thungmahamek,
Sathorn, Bangkok 10120, Thailand
Tel: 662-3449999, Fax: 662-3449968
<http://www.canon.co.th>

CANON MARKETING (PHILIPPINES) INC.

Marvin Plaza Building, 2153 Don Chino Rocas Ave,
Makati City, Metro Manila, Philippines
Tel: 632-8126047, Fax: 632-8120067/8109797

CANON INDIA PVT LTD.

Neela Gagan, Mandi Road,
Mehrauli, New Delhi-110030, India
Tel: 91-11-6806572, Fax: 91-11-6807180

CANON HONGKONG CO., LTD.

9/F, The Hong Kong Club Building
3A Chater Road, Central, Hong Kong
TEL: (852) 2739 0802
FAX: (852) 2739 6428

CANON AUSTRALIA PTY. LTD.

1 Thomas Holt Drive, North Ryde, Sydney N.S.W. 2113,
Australia
Info-Line: (02) 9805 2864

CANON NEW ZEALAND LTD.

Fred Thomas Drive, Takapuna
P.O. Box 33-336, Auckland, New Zealand
Info-Line: 0900-522666

ADOBE SYSTEMS INCORPORATED

<http://www.adobe.com>

ARCISOFT, INC.

<http://www.arcsoft.com>

SCANSOFT, INC.

<http://www.scansoft.com>

Canon Color Image Scanner

CanoScan N670U/N676U/N1240U

Quick Start Guide



System Information

This form is used to record the operating environment of the purchased scanner. If any problems occur with the scanner, you will need this information when you contact our Customer Support Help Desk. Please make sure to record this and secure it safely.

- When a repair is needed, warranty information is required. Please make sure to record this information and secure it carefully.
- The maintenance service of this equipment expires in seven years after production ceases.

Date of Purchase:

Dealer:

Tel:

Dealer Address:

Scanner Model: CanoScan N670U N676U N1240U

Serial Number (on the back of the equipment):

• About the Computer Used

Manufacturer:

Model:

CPU:

Clock Speed:

MHz

Memory Capacity (RAM):

MB

Hard Disk Capacity:

MB

Space Available:

MB

OS : Windows Me 98 2000 Mac OS 8.6 9.0 9.1 X (Classic)

Monitor Type:

Monitor Size:

Inches

Printer:

Manufacturer:

Type of Printer:

Printer Resolution:

dpi

Installed Virus Protection Program:

Installed Compression Program:

On-Board Expansion Cards:

Attached Peripherals:

Name of Network Connected:

Warning

When you use this product, you should pay attention to the following legal issues:

- Scanning of certain documents, such as bank notes (bank bills), government bonds and public certificates, may be prohibited by law and may result in criminal and/or civil liability.
- You may be required under law to obtain authorization from a person possessing copyrights or other legal rights to the item being scanned.

If you are uncertain of the legality of scanning any particular item, you should consult your legal adviser in advance.

- CanoScan and ScanGear are trademarks of Canon Inc.
- Adobe® Acrobat® and Photoshop® are trademarks of Adobe Systems Incorporated.
- Macintosh, Power Macintosh and Mac OS are trademarks of Apple Computer, Inc., registered in the U.S. and other countries.
- iMac is a trademark of Apple Computer, Inc.
- Microsoft and Windows are registered trademarks of Microsoft Corporation in the U.S. and other countries.
- OmniPage Pro and OmniPage SE are trademarks of ScanSoft, Inc.
- Other names and products not mentioned above may be trademarks or registered trademarks of their respective companies.

Check the Package Contents

Scanner Unit and Accessories

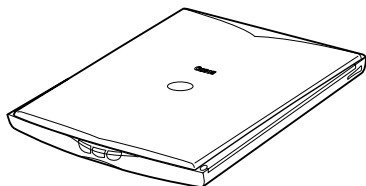

Scanner Unit

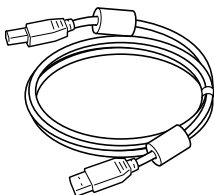

USB Interface Cable

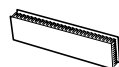

Velcro® Strip

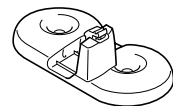

Stand

➔ page 11

Software and Documents

- CanoScan Setup Utility CD-ROM
Contains software programs, PDF manuals, troubleshooting guide, etc.
- Adobe Photoshop CD-ROM (with only CanoScan N1240U)
- Quick Start Guide (this guide)
- Additional documents

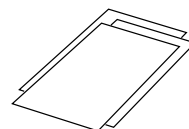
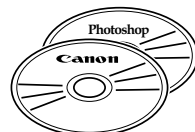

Unlock the Scanning Unit

Unlock the scanner before connecting to the computer. If it is left locked, a malfunction or other problem may occur.

1. Peel the seals off the scanner.
2. Gently turn the scanner over.

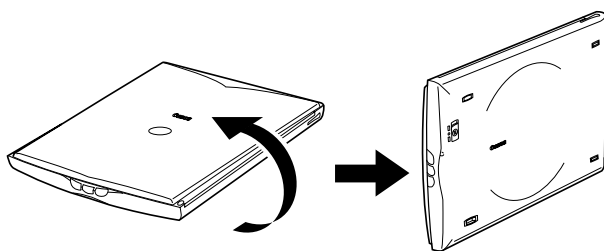

3. Push the lock switch toward the unlock mark.

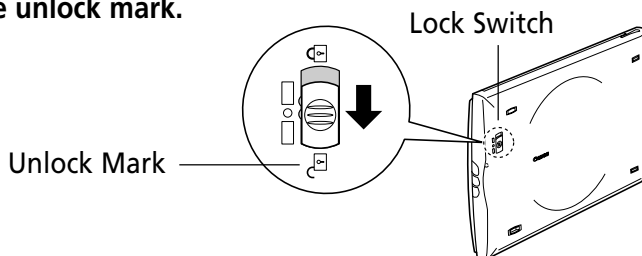

4. Return the scanner to a horizontal position.

Connect the Scanner

Confirm that the power switches for the computer and other connected devices are off.

Connect the scanner to the computer with the supplied USB interface cable.

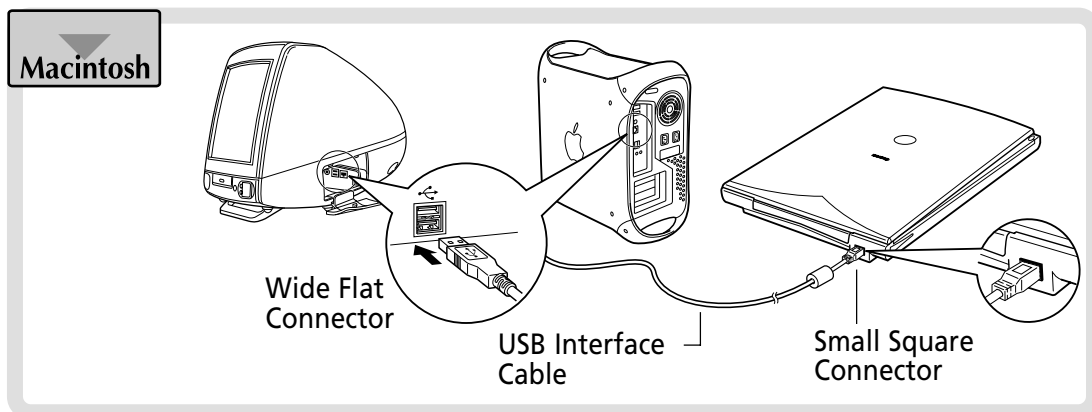
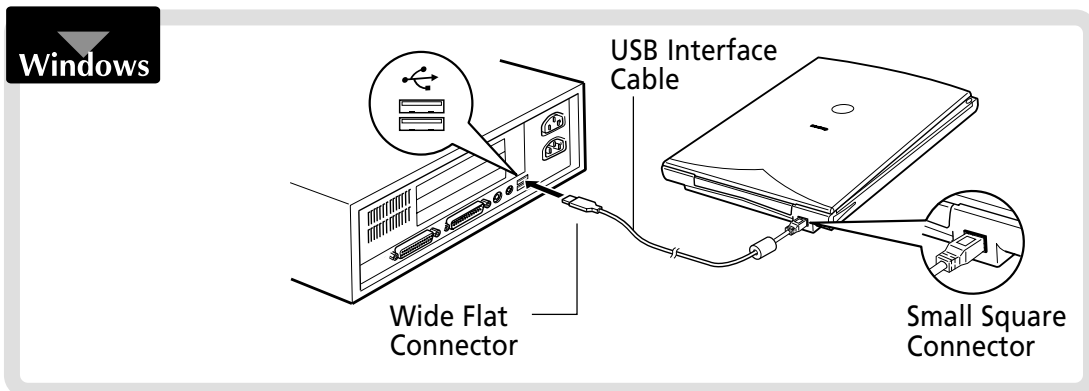

- The scanner does not have a power switch.
The power is activated as soon as the computer is turned on.



➔ Proceed to the next page.



➔ Jump to page 6.

- The screen shots common to both Windows and Macintosh used in this manual are from the Windows platform, unless otherwise noted.
- The scanner used for the screen shot in this manual is N1240U. Scanner name shown in screen shots will vary depending on the model purchased.

Install the Software

1. Install the Driver Software

Install the Driver Software (ScanGear CS-U) with the following procedure.

For Windows 98/2000 Professional users ➡ Jump to page 4.

Windows Millennium Edition

1. Turn the computer on.
2. The [Add New Hardware Wizard] dialog box will appear.
Confirm that "Automatic search for a better driver (Recommended)" is selected.
3. Place the CanoScan Setup Utility CD-ROM in the drive.
4. Wait for 10 seconds, then click [Next].
The driver will begin to install.
5. When "Windows has finished installing the new hardware device." appears, click [Finish].

➡ Jump to page 5.

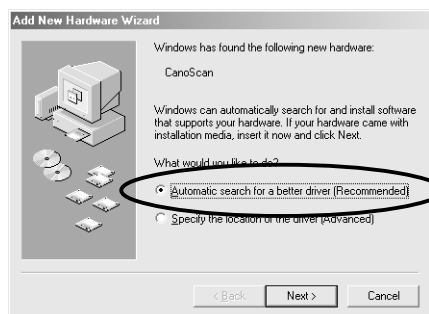

Windows 98 / 2000 Professional

The screen shots in this section are from Windows 98.

1. Turn the computer on.
2. When [Add New Hardware Wizard] appears, click [Next].
3. Confirm that "Search for the best driver for your device. (Recommended)" is selected and click [Next].
4. Place the CanoScan Setup Utility CD-ROM in the drive.
5. Confirm that "CD-ROM drive" is selected, wait for 10 seconds, and then click [Next].
If "Driver Not Found" appears, click [Back] and repeat this step.
6. When "CanoScan N670U/N676U" or "CanoScan N1240U" appears, click [Next].

The driver will begin to install.

Windows 98 Users

If prompted to insert the Windows 98 CD-ROM, follow the instructions below.

- a. Click [OK].
- b. Click [Browse].
- c. Select the CD-ROM drive and click [OK].
- d. Click [OK].

Windows 2000 Professional Users

If the message box "The software you are about to install does not contain a Microsoft digital signature." appears, continue installation by clicking [Yes].

7. Click [Finish].

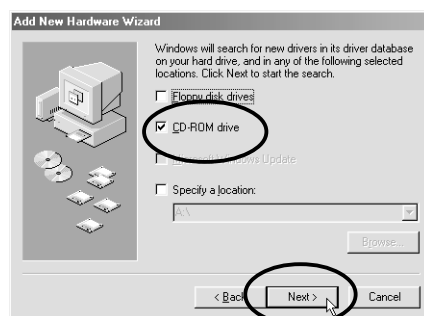
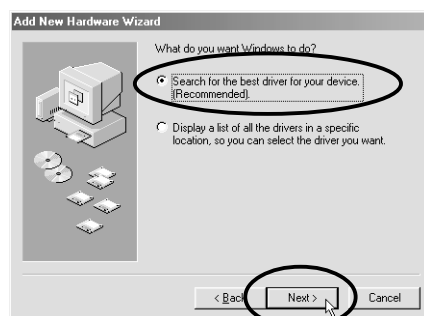
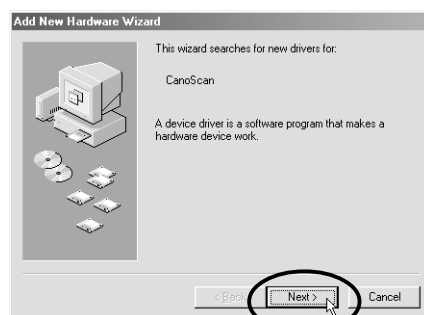

Install the Software

2. Install the Application Software

List of Software to Be Installed (approx. total of 209MB)

- ScanGear Toolbox (10 MB) -Scanning Utility Program
- ArcSoft PhotoStudio 2000 (40 MB) -Image Editing Program
- ArcSoft PhotoBase (60 MB) -Photo Album Program
- ScanSoft OmniPage Pro (75 MB) -OCR (Optical Character Recognition) Program
- Adobe Acrobat Reader (24 MB) -Electronic Manual Viewer Program

Installation Procedures

1. The CanoScan Setup Utility main menu will appear.

If the CanoScan Setup Utility main menu does not automatically appear, eject the CD-ROM and re-insert it.

2. Click [Install the Software].

[Software User License Agreement] is confirmed. Click [Yes] if you accept the agreement.

The [Install] window will display.

3. Click [Start Installation].

4. The installation procedure will start.

Follow the on-screen message prompts and click [Yes] or [Next] to continue the installation.

5. When the installation is complete, click [Yes].

The computer will restart.

6. After Windows restarts, remove the CD-ROM from the drive and store it in a safe place.

➡ Jump to page 7.

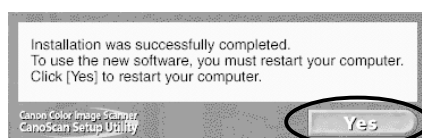

List of Software to Be Installed (approx. total of 94MB)

- ScanGear CS-U (10 MB) -Driver Program
- ScanGear Toolbox (10 MB) -Scanning Utility Program
- ArcSoft PhotoStudio (10 MB) -Image Editing Program
- ArcSoft PhotoBase (10 MB) -Photo Album Program
- ScanSoft OmniPage SE (30 MB) -OCR (Optical Character Recognition) Program
- Adobe Acrobat Reader (24 MB) -Electronic Manual Viewer Program

Installation Procedures

1. Turn the computer on.

When "...Would you like to look for these drivers over the internet?" appears, click [Cancel].

2. Place the CanoScan Setup Utility CD-ROM in the drive.

The CanoScan Setup Utility main menu will appear.

If no window displays, double-click the CD-ROM icon, then the Setup icon.

3. Click [Install the Software].

[Software User License Agreement] is confirmed. Click [Yes] if you accept the agreement.

The [Install] window will display.

4. Click [Start Installation].

5. The installation procedure will start.

Follow the on-screen message prompts and click [Yes], [Next] or [Install] to continue the installation.

6. When the installation is complete, click [Yes].

The computer will restart.

7. After restarting, remove the CD-ROM from the drive and store it in a safe place.

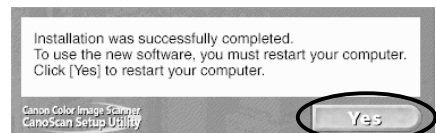
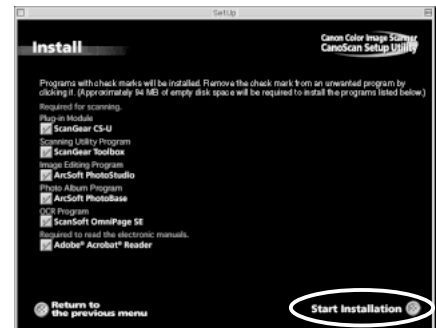

Try Scanning

1. Place an item (photo or picture) on the glass.

Place the item face down and align its top edge with the alignment mark at the front left corner of the glass.

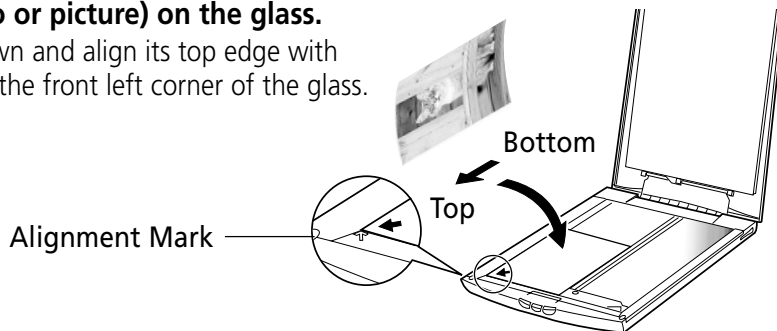

2. Select [Start], [Programs], [ArcSoft PhotoStudio 2000] and [PhotoStudio 2000].

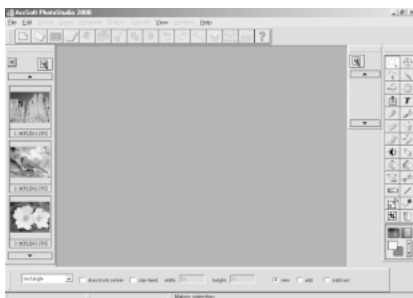
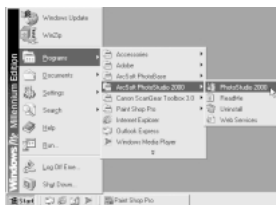

PhotoStudio 2000 will start.

< If you install another scanner or a digital camera, select this scanner. >

- Click the [File] menu and select [Select Source].
- Highlight [CanoScan N670U/N676U] or [CanoScan N1240U] and click [Select].



2. Double-click the [ArcSoft PhotoStudio] folder and double-click the [PhotoStudio] icon.



PhotoStudio™

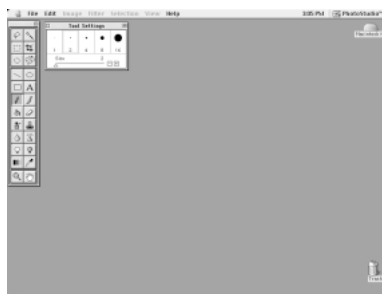

PhotoStudio will start.



3. Click the Acquire icon . ScanGear CS-U will start.

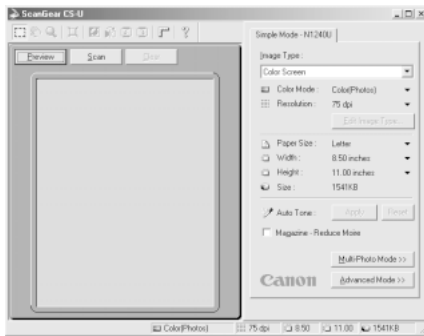

3. Click the [File] menu and select [Acquire] and [ScanGear CS-U 6.2.0...]. ScanGear CS-U will start.

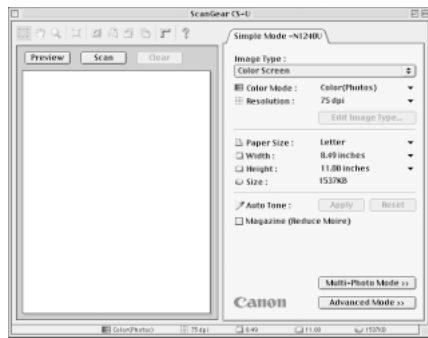
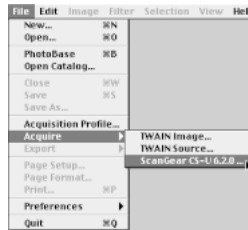

4. Click [Preview]. After calibration, the preview scan will start and gradually display the image.

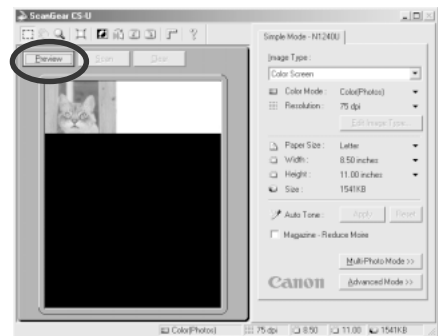

5. Drag the mouse diagonally to select the area you want to scan.

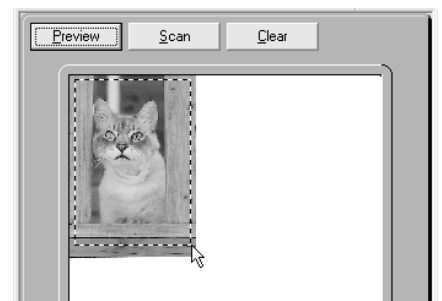

Try Scanning

6. Click [Scan].

The final scan will start.

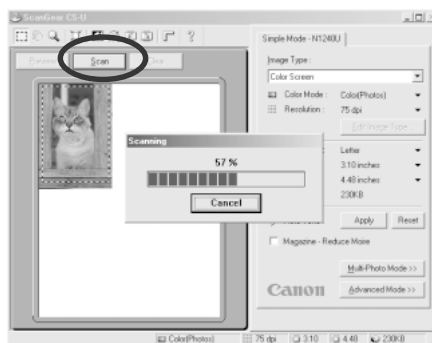

7. The scanned image will appear in the PhotoStudio window.

8. Save the scanned image.

Click the [File] menu and select [Save As]. Select the folder where you wish to store the image file, enter a file name and select a file type, and click [Save].



9. Click the or (close box) in the PhotoStudio window to close it.

You have now confirmed the scanner operation. You should now be ready to explore the possibilities of the bundled software.

For details about the bundled software, read the Product Guide or User's Guide for each software program contained on the CanoScan Setup Utility CD-ROM as PDF manuals.

If the scanner does not perform as described above, read the [Troubleshooting] section of the CanoScan Setup Utility CD-ROM.

Using the Scanner Buttons

You can use the 3 convenient buttons on the front of the scanner, to scan and perform related tasks easily, with a single touch of the button. Place an item on the scanner before pressing a button.

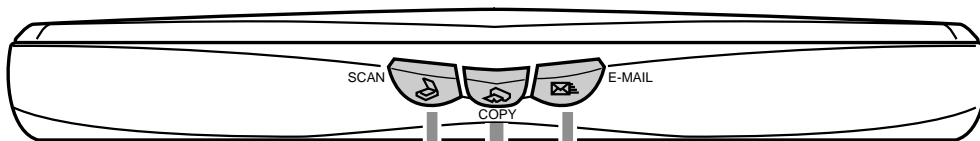

[SCAN] Button

To Open the scanned image in the ArcSoft PhotoBase window

1. Press the [SCAN] button.
2. The item is scanned.
3. The scanned image will appear in the PhotoBase window.

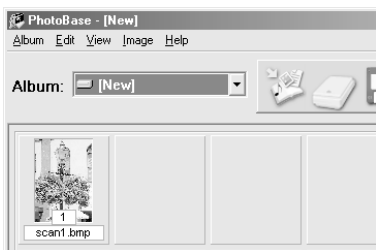

[COPY] Button

To Print (Copy) the scanned image with a printer

1. Press the [COPY] button.
 2. The item is scanned.
 3. The scanned image will print.
- The printer driver should be installed and the printer should be on-line to use this function.

[E-MAIL] Button

To E-mail the scanned image as an attached file

1. Press the [E-MAIL] button.
2. The item is scanned.
3. The [E-mail software selection] dialog appears. Select one from the list and click [OK].
 - Required only for the first scan.
4. The e-mail software will start, and the scanned image will be attached in a new message window.

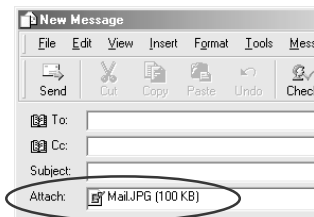

5. Enter the receiver's address, title, message, confirm the required settings, and send the message.

- For Windows, MAPI compliant e-mail software, such as Microsoft Outlook Express, Microsoft Outlook, Eudora, should be installed and enabled. With certain mail software, you should set the MAPI function on.

- To use these buttons, ScanGear CS-U, ScanGear Toolbox and ArcSoft PhotoBase should be installed from the CanoScan Setup Utility CD-ROM.
- While scanning, you can change the default settings for scanning by clicking the [Cancel] button. For details on changing settings or arranging the scanner's button-to-function assignment, refer to the ScanGear Toolbox User's Guide (PDF manual).

Using the Scanner in the Vertical Position

1. Attaching the Velcro® Strip

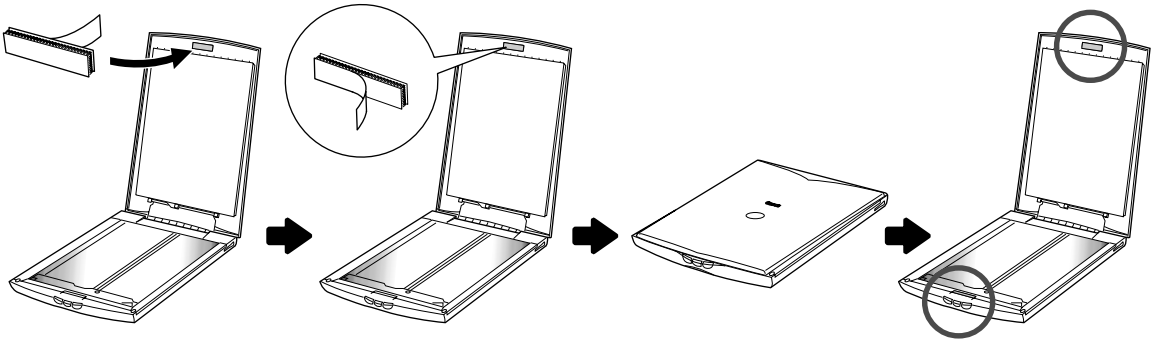

2. Installing the Stand

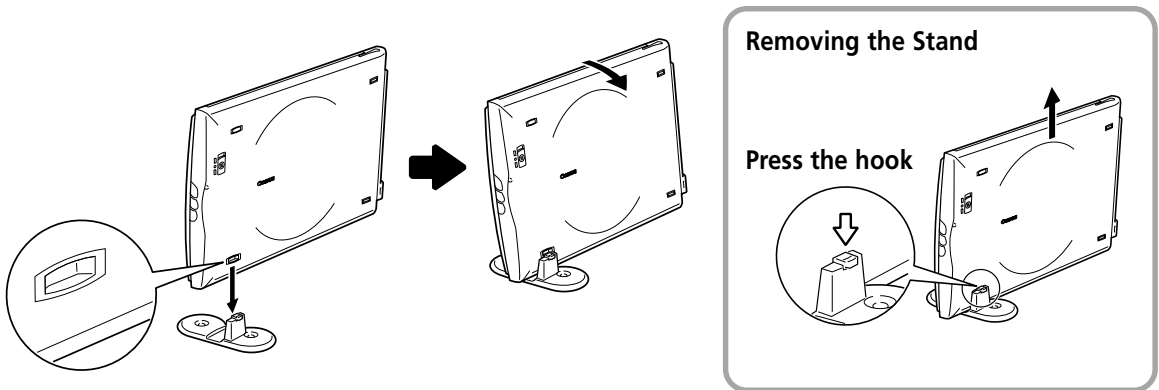

3. Positioning an Item

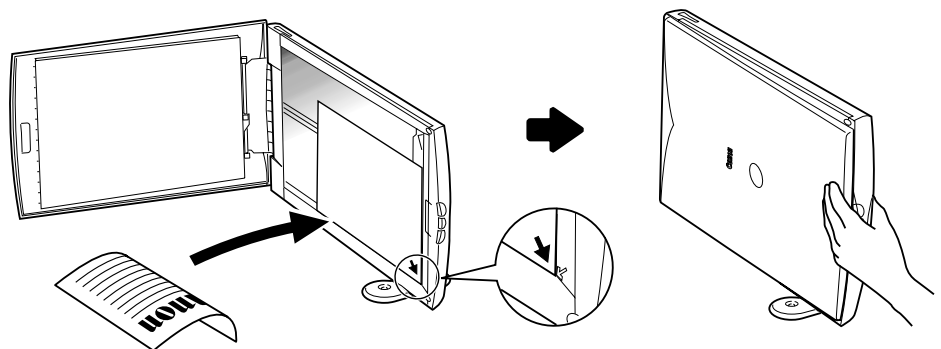

Specifications

	CanoScan N670U/N676U		CanoScan N1240U
Scanner Type	Flatbed		
Scanning Element	CIS (Contact Image Sensor)		
Light Source	3-color (RGB) LED		
Optical Resolution	600 x 1200 dpi	1200 x 2400 dpi	
Selectable Resolution	25 - 9600 dpi (ScanGear CS-U)		
Scanning Bit Depth	Color	16 bit input / 8 bit output for each color (RGB)	
	Grayscale	16 bit input / 8 bit output	
Scanning Speed* ¹	Color	16 msec/line (600 dpi)	16 msec/line (600 dpi)
			32 msec/line (1200 dpi)
	Grayscale	5.3 msec/line (600 dpi)	5.3 msec/line (600 dpi)
	B&W	5.3 msec/line (600 dpi)	10.6 msec/line (1200 dpi)
			5.3 msec/line (600 dpi)
Preview Speed* ²	15 sec (approx.)		
Interface	USB 1.1		
Maximum Document Size	A4/Letter: 216 x 297mm (8.5 x 11.7 in.)		
Scanner Buttons	3 buttons : SCAN, COPY, E-MAIL		
Operating Range	Temperature	5° to 35° C (41° to 95° F)	
	Humidity	10 % to 90 % RH (without condensation formation)	
Power Requirements	Supplied via USB port		
Power Consumption	In operation: 2.5 watts maximum Stand-by: 1.25 watts		
Maximum Exterior Dimensions	256 x 383 x 34mm (10.1 x 15.1 x 1.3 in.)		
Weight	Approximately 1.5 kg (3.3 lbs.)		

*¹ Transfer time to computer is not included.

*² Calibration processing time is not included.

- Specifications are subject to change without notice.